

Viewfinder Monitor

Operation Manual_ver 1.7

VFM-056W

VFM-056WP



TVlogic Always ON-AIR

Contents

| | |
|---------------------------------|----|
| 1. Caution | 04 |
| 2. Components | 06 |
| 3. Main Features | 07 |
| 4. Controls & Functions | 08 |
| 5. Menu Tree & Adjustment | 10 |
| 6. Menu Operations | 11 |
| [1] Picture | 11 |
| [2] Color | 11 |
| [3] Marker | 12 |
| [4] Display / Video | 13 |
| [5] Waveform | 15 |
| [6] Audio | 18 |
| [7] System | 19 |
| 7. Button Functions | 20 |
| 8. Other Functions | 21 |
| 9. Product Specifications | 30 |
| 10. Optional Accessories | 31 |

FCC (Federal Communications Commission)

This equipment has been tested and found to comply with the limits for class A digital device, pursuant to part 15 of the FCC Rules. These limits are designed to provide reasonable protection against harmful interference when the equipment is operated in a commercial environment.

This equipment generates, uses and can radiate radio frequency energy and if not installed and used in accordance with the instruction manual, may cause harmful interference to radio communications. Operation of this equipment in a residential to correct the interference at his own expense

CAUTION: Change or modifications not expressly approved by the manufacturer responsible for compliance could void the user's authority to operate the equipment.

Disposal of Old Electrical & Electronic Equipment

(Applicable in the European Union and other European countries with separate collection systems)

This symbol on the product or on its packing indicates that this product shall not be treated as household waste. Instead it shall be handed over to the applicable collection point for the recycling of electrical and electronic equipment. By ensuring this product is disposed of correctly, you will help prevent potential negative consequence for the environment and human health, which could otherwise be caused by inappropriate waste handling of this product. The recycling of materials will help to conserve natural resources.

1. Caution

- **Always use set voltage. (DC 6~12V)**
- All operating instructions must be read and understood before the product is operated. These safety and operating instructions must be kept in safe place for future reference.
- All warnings on the product and in the instructions must be observed closely.
- All operating instructions must be followed.
- Do not use attachments not recommended by the manufacturer. Use of inadequate attachments can result in accidents.
- This product must be operated on a power source specified on the specification label.
- If you are not sure of the type of power supply used in your home, consult your dealer or local power company. For units designed to operate on batteries or another power source, refer to the operating instructions.
- The power cords must be routed properly to prevent people from stepping on them or objects from resting on them. Check the cords at the plugs and product.
- In case of using other 12V DC adapters instead of the standard adapter provided by the manufacturer, please check the proper load capacity (or current capacity) and use an adapter with stable voltage.
- Do not overload DC outlets or extension cords. Overloading can cause or electric shock.
- Never insert an object into the product through vents or openings. High voltage in the product, and inserting an object can cause electric shock and/or short internal parts. For the same reason, do not spill water or liquid on the product.
- Do not attempt to service the product yourself. Removing covers can expose you to high voltage and other dangerous conditions. Request a qualified service person to perform servicing.
- If any of the following conditions occurs, unplug the power cord from the DC outlet, and request a qualified service person to perform repairs.
 - a. When the power cord or plug is damaged.
 - b. When a liquid was spilled on the product or when objects have fallen into the product.
 - c. When the product has been exposed to rain or water.
 - d. When the product does not operate properly as described in the operating instructions. Do not touch the controls other than those described in the operating instructions. Improper adjustment of controls not described in the instructions can cause damage, which often requires extensive adjustment work by a qualified technician.
 - e. When the product has been dropped or damaged.
 - f. When the product displays an abnormal condition. Any noticeable abnormality in the product indicates that the product needs servicing.
- In case the product needs replacement parts, make sure that the service person uses replacement parts specified by the manufacturer, or those with the same characteristics and performance as the original parts. Use of unauthorized parts can result in fire, electric shock and/or other danger.
- Upon completion of service or repair work, request the service technician to perform safety checks to ensure that the product is in proper operating condition.

1. Caution

- When mounting the product on a wall or ceiling, be sure to install the product according to the method recommended by the manufacturer.
- Unplug the power cord from the DC outlet before cleaning the product. Use a damp cloth to clean the product. Do not use liquid cleaners or aerosol cleaners.
- Unplug the power cord from the AC outlet if you do not use the product for considerably long time.
- Do not use the product near water, such as bathtub, washbasin, kitchen sink and laundry tub, swimming pool and in a wet basement.
- Keep the product away from direct rays of the Sun-light.
- Do not place the product on an unstable cart, stand, tripod or table. Placing the product on an unstable base can cause the product to fall, resulting in serious personal injuries as well as damage to the product. Use only a cart, stand, tripod, bracket or table recommended by the manufacturer or sold with the product. When mounting the product on a wall, be sure to follow the manufacturer's instruction. Use only the mounting hardware recommended by the manufacturer.
- When relocating the product placed on a cart, it must be moved with the utmost care.
- Sudden stops, excessive force and uneven floor surface can cause the product to fall from the cart.
- The vents and other openings in the cabinet are designed for ventilation. Do not cover or block these vents and openings since insufficient ventilation can cause overheating and/or shorten the life of the product. Do not place the product on a bed, sofa, rug or other similar surface, since they can block ventilation openings. This product is not designed for built-in installation; do not place the product in an enclosed place such as a bookcase or rack, unless proper ventilation is provided or the manufacturer's instructions are followed.
- In case of installation the product on the rack, the inside of the product would be overheated due to heat from other devices near by and the decrease of air circulation, which could damage to the monitor. To prevent the damage, please have enough space for the monitors and use fan to avoid heat and maintain the operating temperature. (Refer to the specification of the product).
- The LCD panel used in this product is made of glass. Therefore, it can break when the product is dropped or applied with impact. Be careful not to be injured by broken glass pieces in case the LCD panel breaks.
- Keep the product away from heat sources such as radiators, heaters, stoves and other heat generating products (including amplifiers).

2. Components

VFM-056W/VFM-056WP

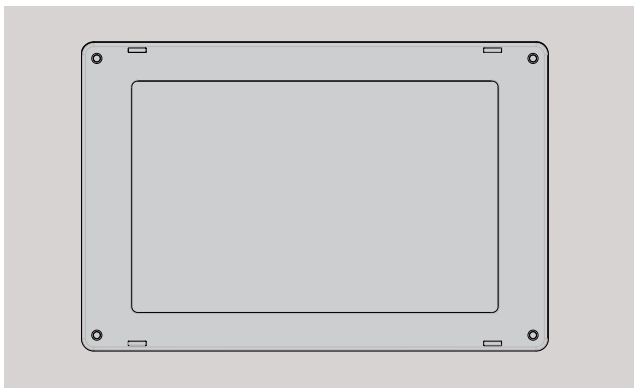

Camera Mount

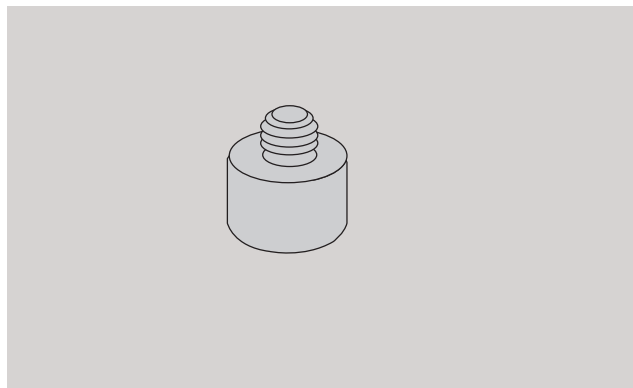

DC Power Adapter

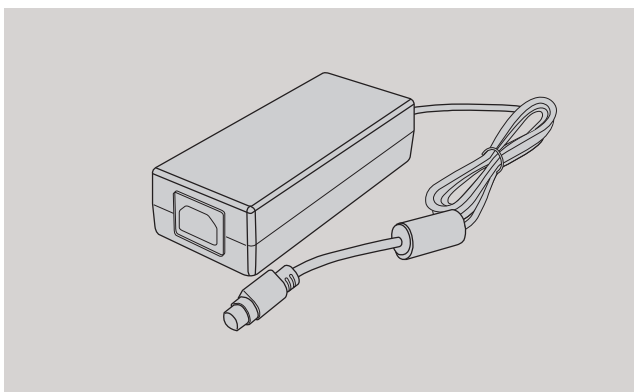

BNC Connector (Angle Type)

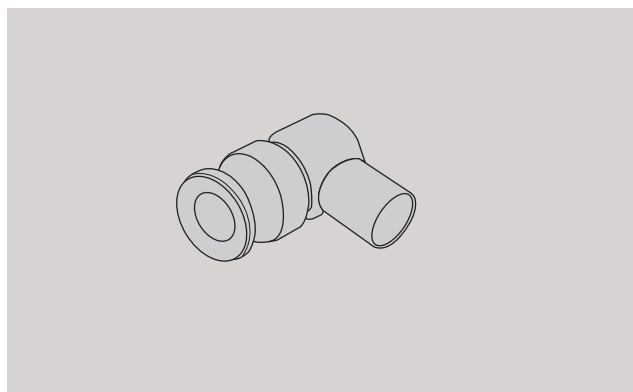

AC Power Cord

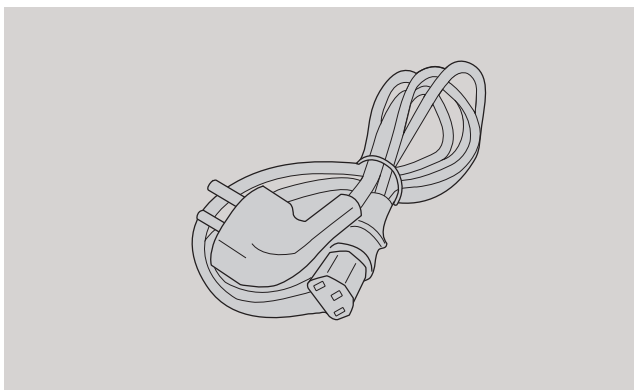

* **Optional Accessories :** Please note the optional accessories on page 31

3. Main Features

VFM-056W/VFM-056WP Monitor contains the following features:

- **Compatible with various SDI signals formats (SD/HD/3G)**
 - This product is compatible with various SDI signals - SD/HD/3G(A/B)-SDI
 - * 3G-SDI signal supports at VFM- 056WP. (Only Premium version)
- **Compatible with various analog signals**
 - This product is compatible with various analog signals such as CVBS(Composite), S-Video and YPbPr(Component).
- **HDMI(with HDCP) Signal**
 - HDMI(w/ HDCP) input is available without any other accessory.
- **HDMI To SDI Conversion Output (VFM-056WP Only)**
 - VFM-056WP features an HDMI To SDI conversion output.
- **Temperature Adaptive Color**
 - VFM-056W/WP provides a self-adjustment function for white balance(or color temperature) utilizing internal sensor that measures the temperature of the LCD panel
- **All-in-one type system**
 - Slim and all-in-one type monitor that supports various video formats.
- **Wide Screen / Wide Viewing Angle**
- **WaveForm/Vectorscope/Audio Level Meter Function**
 - WaveForm & Vectorscope (VFM-056WP only)
 - 2 X Zoom (VFM-056WP Only)
 - Embedded Audio Level Meter
- **Audio Out**
 - Internal Speaker(activates only with input signals with Embedded Audio)
 - Stereo Audio Out through phone Jack.
- **Knob Control**
 - Easy to adjust user configuration using the control knob on the side of the monitor.
- **BLUE ONLY/MONO/Focus Assist/H/V Delay Function**
- **Range Error/Luma(Y') Zone Check (Color/Zebra Type) Function (VFM-056WP only)**
- **Internal Pattern Generator (0~100% Gray/ColorBar+Pluge)**
- **Markers & Safety Areas**
 - Center Marker, Safety Area Marker, Aspect Marker, Display Size(Scan)
- **Pixel To Pixel/Zoom mode**
 - Used to display the original image resolution without scaling to match a certain resolution or an aspect ratio.
 - Select 'Pixel to pixel' to display unscaled images, and select 'Zoom' to enlarge the original image.
 - Zoom Scroll Function (Left/Right,Top/Bottom)
- **Power**
 - Basically, the product is powered by normal DC source.
 - The product can be battery-powered.
 - * VFM-056W/P : DC 6~12V (Typical)
- **Additional features**
 - Camera Mounting Hole x 4, VESA Mounting Standard, Screen Tally Function, 300cd/m² Brightness, 500 : 1 Contrast, OSD user interface

4. Controls & Functions

FRONT/SIDE/REAR/TOP

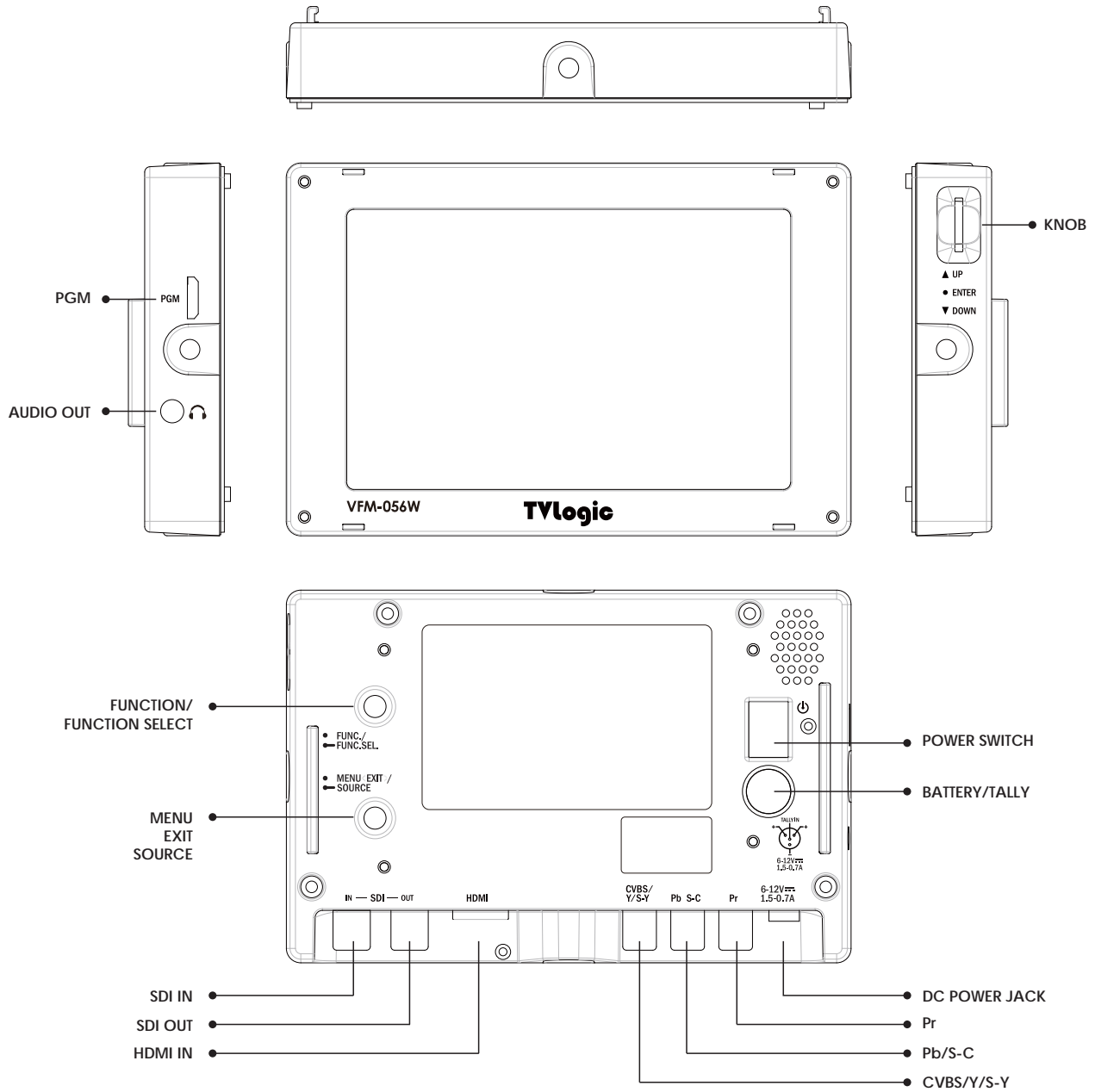

5. Controls & Functions

SIDE

- **PGM (Mini HDMI)**
 - This terminal is used to upgrade the firmware or color calibration made by TVLogic.
- **AUDIO OUT (Phone Jack)**
 - Used for Stereo Audio Output through Phone Jack. (video signals with embedded audio only)
- **ENCODER Knob**
 - Scroll up and down the Knob to move the cursor and press the Knob to select an item.
 - Used to move within the menu when OSD menu is activated, and is also used to decrease or increase the value of the selected feature.
 - When OSD menu is inactivated, press the knob to adjust the value of Brightness, Contrast, Chroma, Aperture or Volume.
 - In Pixel to Pixel mode, scroll the knob to move the displayed area from clockwise or counterclockwise.
 - In Luma(Y') Zone Check mode, it is used to adjust the value.
 - Press the knob to select the main menu and sub menus.

REAR

- [● **FUNC./** ● **FUNC. SEL.**] Button
 - Press the button for less than 2 seconds to activate designated FUNCTION.
 - Press the button for more than 2 seconds to activate the Function Select menu. (Scan, Aspect, H/V Delay, etc)
 - After pressing the button for more than 2 seconds, the function which was selected previously is displayed. Use the Knob to change the function.
 - * Function Select button can be set in the main menu [SYSTEM].
- [● **MENU<EXIT>/** ● **SOURCE**] Button
 - Press the button for less than 2 seconds to activate the main OSD menu.
 - Used to return from sub menu to main menu.
 - Press the button for more than 2 seconds to activate Input Select menu. (SDI, HDMI, CVBS, S-Video, Component Video)
 - Use the Knob to change the Input Signal.

- **SDI-IN (BNC)**
 - Select SD/HD/3G-SDI Signal.
- **SDI-OUT (BNC)**
 - SD/HD-SDI Signal Output which is input through [SDI-IN] terminal.
 - Used to convert the HDMI Signal and output through HD-SDI terminal.
- **HDMI IN (HDMI)**
 - Select HDMI Signal which is input through [HDMI] terminal.
- **CVBS/Y/S-Y (RCA)**
 - Select CVBS (Composite Video), Component Y' or S-VIDEO Y' signals.
- **Pb/S-C (RCA)**
 - Select Component Pb or S-VIDEO C' signals.
- **Pr (RCA)**
 - Select Component Pr signal.
- **DC POWER IN (DC Adapter)**
 - DC power input terminal for DC 6~12V.
- **BATTERY/TALLY (XLR 4P)**
 - Tally Signal In/Out
 - Battery Power Input : DC 12V
 - * Rated Power Input : DC 6~12V (0.7~1.5A)

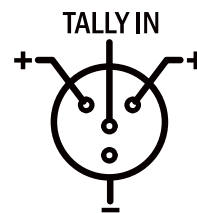

| Connector | Composite | Component | S-Video |
|-----------|-----------|-----------|---------|
| 1 | CVBS | Y | Y |
| 2 | No Con. | Pb | C |
| 3 | No Con. | Pr | No Con. |

<Warning!!>

When using the product make sure to ground before connecting the input signal line. The unit may not operate properly if the input line is connected before the GND is connected.

5. Menu Tree & Adjustment

[1] Menu Tree

- OSD (On-Screen Display) Menu helps you use various functions.
- This Picture is the menu structure for VFM-056W/VFM-056WP.



[3] Menu Control Sequence

1. Press MENU button to activate the OSD menu.
2. Move to a desired menu by scrolling the Knob.
3. Press the Knob to select a menu and move to select a sub-menu by scrolling the Knob.
4. Press the Knob to select the desired sub menu. (The selected sub-menu will be highlighted)
5. Press ENTER button or MENU button to save the new value after adjusting the value by scrolling the Knob.
6. Press MENU button to return to previous menu and if there is no previous menu, the OSD menu will be removed from the screen.

[2] Menu Control

- User may control various functions using MENU button on the back and the Knob on the side of the monitor.

6. Menu Operations

[1] Picture



- **Brightness**
 - Used to set the brightness(=offset) level from -100 to 100.
 - # Press the Knob to adjust Brightness quickly.
- **Contrast**
 - Used to set the contrast(gain) level from -100 to 100.
 - # Press the Knob to adjust Contrast quickly.
- **Chroma**
 - Used to set the saturation level from -50 to 50.
 - # Press the Knob to adjust Chroma quickly.
- **Phase**
 - Used to set the hue(phase) level from -40 to 40. (Activated only when NTSC or PAL video signal is input through Composite Video or S-Video terminal.)
- **Aperture**
 - Used to set the sharpness level from -5 to 19.
 - # Press the Knob to adjust Aperture quickly.
- **NTSC Setup**
 - Used to set Black Level of NTSC video as 0(zero setup) or 7.5 IRE.
 - Activated when NTSC video signal is input through Composite 1/2/3 or S-VIDEO terminal.
- **Knob Lock**
 - Locks the Knob control(APERTURE, BRIGHT, CHROMA, CONTRAST, VOLUME).

[2] Color



- **Color Temp.**
 - Controls color temperature and allows instant access to preset color temperature settings.
 - Available color temperatures are 3200K, 5000K, 5600K, 6500K, 9300K and User 1/2/3.
 - In User 1/2/3 modes, user can define custom RGB GAIN and BIAS (=Offset) values.
- **Gain Red/Green/Blue**
 - Used to set R/G/B Gain(or Picture, Contrast) level from -256 to 255.
 - # Only available in User 1/2/3 mode.
- **Bias Red/Green/Blue**
 - Used to set R/G/B Bias(or Offset, mainly affects on Black level) from -100 to 100.
 - # Only available in User 1/2/3 mode.
- **Color Copy**
 - Used to copy the R/G/B Gain value of pre-stored color temperature settings.
 - In User mode, find and select the color temperature and press Enter button to copy and apply the Gain value to GAIN RED, GAIN GREEN, GAIN BLUE.
 - # Only available in User 1/2/3 mode.
- **Temperature Adaptive Color**
 - [On] : Used to measure and compensate the color temperature shift caused by panel temperature variation.
 - [Off] : Used to apply preset color temperature setting regardless of the panel temperature.

6. Menu Operations

[3] Marker



- Marker Enable**
 - Used to activate the Marker function.
- Marker Type**
 - Used to select the marker type.
 - Available marker types are OFF, 16:9, 4:3, 4:3 ON AIR, 15:9, 14:9, 13:9, 1.85:1, 2.35:1, 1.85:1 & 4:3 and USER.
- Center Marker**
 - Displays the Center Marker on the screen.
- Safety Area**
 - Used to select to display and controls the size and availability of the Safety Area.
 - Available sizes are 80%, 85%, 88%, 90%, 93%, 100%, EBU ACTION 16:9, EBU GRAPHIC 16:9, EBU ACTION 14:9, EBU GRAPHIC 14:9, EBU ACTION 4:3 and EBU GRAPHIC 4:3.
- Fit Marker**
 - Used to activate or inactivate the Fit Marker function.
 - When the Marker type is selected in the Marker menu, a border line of the Safety Area will be displayed inside the Marker. Images below show the difference between Fit Marker ON and OFF.



MARKER : 4:3
SAFETY AREA : 90%
FIT MARKER : OFF

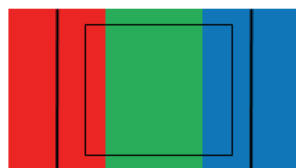

MARKER : 4:3
SAFETY AREA : 90%
FIT MARKER : ON

- Marker Mat**
 - Used to set the darkness level outside of the MARKER area from OFF(transparent) to 7(Black).
 - The bigger the value, the darker the color.
- Marker Color**
 - Used to set the color of the MARKER lines.
 - Available colors are white, gray, black, red, green and blue.
- Marker Thickness**
 - Used to set the thickness of the MARKER lines.
 - Thickness level is from 1 to 7 by the pixel unit.
- USER Marker H1**
 - Used to set the position of the first horizontal marker line.
 - Displayed when MARKER menu is set to USER.
- USER Marker H2**
 - Used to set the position of the second horizontal marker line.
 - Displayed when MARKER menu is set to USER.
- USER Marker V1**
 - Used to set the position of the first vertical marker line.
 - Displayed when MARKER menu is set to USER.
- USER Marker V2**
 - Used to set the position of the second vertical marker line.
 - Displayed when MARKER menu is set to USER.

6. Menu Operations

[4] Display/Video



• Scan

- Used to change the Scan mode. Scroll up and down the Knob and the mode will be changed as the following sequence.

- [Zero Scan] -> [Over Scan] -> [Pixel-To-Pixel] -> [User Aspect]

* See section "Other Functions [1] Pixel to Pixel" on page 21 for more information.

[USER ASPECT]: User can control the aspect ratio by adjusting width and height of the display.

- See section "Other Functions [2] User Aspect" on page 22 for more information.

• Aspect

- Used to change Aspect Ratio.

- Regardless of the original Aspect ratio of the Input Signal, the Aspect Modes are changed as follow sequence. : [16:9][4:3][2.35:1][1.85:1][15:9][16:10][Auto]

* [Auto] mode enables the Aspect Ratio of the outout signal to be synchronized to the original Aspect Ratio of the input signal.

• H/V Delay

- Used to monitor the Blanking area for H sync and V sync.

• Blue Only

- Used to switch in the order of [Off]-[Blue Only]-[Mono]-[Off].

- Press the button to remove red and green components from the input signal and display blue componet only.

- Press the button again to switch to mono-chrome mode which has no chroma signal.

• User Aspect Horizontal/User Aspect Vertical

- Activated only when [SCAN] mode is set to [User Aspect].

- User can adjust the Horizontal and Vertical size of the screen.

- See section "Other Functions [2] User Aspect" (page 22) for more information.

• Pixel To Pixel Position

- Activated only when [SCAN] mode is set to [Pixel-To-Pixel].

- When the resolution of the input video signal(ex. 1920×1080) is higher than that of the monitor(1280×800), only area equivelant to 1280×800 out of the 1920×1080 will be displayed in the [Pixel to Pixel] mode.

* See section "Other Functions [1] Pixel to Pixel" for more information.

• 3G Format (VFM-056WP Only)

- Used to select 3G-SDI A/B input format among NORMAL MODE(AUTO - A 422 10BIT_YCbCr 50/60P), A 444 10/12BIT_YCbCr, A 444 10/12BIT_RGB, A 422 12BIT_YCbCr, B 444 10/12BIT_YCbCr, B 444 10/12BIT_RGB, B 422 12BIT_YCbCr, B 422 10BIT_YCbCr 50/60P.

- In NORMAL MODE, automatically detected when Payload signal is contained.

6. Menu Operations

[4] Display/Video



● Zoom

- Used to magnify the image up to 90% on a pixel basis and is displayed on full screen.
- * (e.g., 10% Zoom : If the input signal's resolution is 1920 x 1080, only 90% (1728(H) x 976(V)) of the image would be shown on full screen without 10% (192(H) x 108(V)) of the image.)
- * See section "Other Functions [5] Zoom" on page 24 for more information.

● Zoom Width Scroll

- Activated when [Zoom] mode is selected.
- Used to move the enlarged image to the left/right by scrolling the Knob.

● Zoom Height Scroll

- Activated when [Zoom] mode is selected.
- Used to move the enlarged image to the Up/Down by scrolling the Knob.

● DSL R SCALE

- This is a special function for CANON/NIKON DSLR cameras.
- Used to scale the image with different resolution as to the operation mode(Live View/Record/ PlayBack) of the camera to fulfill the screen.
- * See section "Other Functions [9] DSL R SCALE" on page 27 for more information.

● DSL R Camera Sel.

- Select the DSLR camera to be used with VFM-056W/WP. [DSL R SCALE] function. Available models are [CANON 5D/7D] and [NIKON D7000].
- * DSLR cameras' screen size and aspect ratio of Live / Record / Playback modes vary according to their manufacturer.

● Focus Assist

- Focus Assist helps the shooters to easily find out the exact area in the picture with good focus, simply by adding colors on the shape or boundaries of the object in the picture.
- Activates in order of [(Mono) On][(Color) On][Off]
- * (Color) On : Only the boundary of the area with good focus is displayed with the designated color.
- * (Mono) On : The boundary of the area with good focus is colored with the designated color, while the rest of the areas(pixels) have only Y'(Luma) signals to be black & white image.
- * See section "Other Functions [7] Focus Assist" on page 26 for more information.

● Focus Assist Color

- Used to select a color for FOCUS ASSIST among red, green and blue.

● Focus Assist Level

- Used to set the edge difference value between the edges in an image.
- Available values are from 0 to 100. Larger value means more sophisticated detail detection.
- Designated color is displayed when the difference of the edges exceeds the previously set value.
- This feature is available only when the FOCUS ASSIST mode is activated.

6. Menu Operations

[4] Display/Video



- **TimeCode**
 - Used to set the time code among OFF, VITC and LTC.
- **Image Mirror (Hor.)**
 - Used to reverse the left and right of the image.
 - The OSD menu is also reversed.
- **Screen TALLY On/Off**
 - Used to set Tally operation according to the input level of TALLY IN terminal which is among the terminals of XLR 4P connector in the rear.
- **Screen TALLY Operating Level**
 - Used to set the input level of Tally operation. (Open&Low : less than 0.6V, High : more than 2.5V)
 - High: Set the level as "High" to activate the Tally and set the level as "Low" to inactivate the Tally.
 - Low: Set the level as "Low" to activate the Tally and set the level as "High" to inactivate the Tally.
- **Screen TALLY Color**
 - Used to set Tally color.
 - Available colors are Red, Green and Yellow.

[5] Waveform/Level Check (VFM-056WP Only)



- **Waveform/Vector**
 - Used to select among [Off], [Waveform Y], [Waveform Cb], [WaveForm Cr], [Vectorscope].
 - Waveform or Vectorscope is displayed on the bottom right of the screen.
 - Vectorscope : Displays the color components B'-Y' and R'-Y' of the input signals on the X-Y axis.
 - Is classified into two kinds depending on the input signal – SD or HD. 100% and 75% are indicated on the screen.
 - Waveform YCbCr: Displays each waveform for luma(Y') and Cb/Cr components of the input signal.
- **Waveform Intensity**
 - Used to set the brightness level of the Waveform/ Vectorscope display from 1 to 63.
 - The higher the number the brighter the waveform will be.
- **Waveform Trans.**
 - Used to select the transparency option of the Waveform/ Vectorscope between Opaque and Blend.
 - Even if the option is set to [Opaque], it will automatically turn to [Blend] when the main OSD overlaps the waveform/vectorscope. And turns back to [Opaque] when the main OSD disappears.

6. Menu Operations

[5] Waveform / Level Check (VFM-056WP Only)



● Waveform Size

- Adjust the size of the Waveform or Vectorscope.
- May select among [Small], [Large] and [Full].
- * See section "Other Function [3] Waveform/ Vectorscope" on page 22 for more information.

● Line Waveform

- Used to select whether the entire data or one line data will be displayed on the Waveform/ Vectorscope.

● Select Line Position

- Used to select specific Vertical Line for Waveform/Vectorscope.
- It is available when LINE Waveform is activated.
- To activate this feature, go to [WFM/LevelCHK]-[Waveform/Vector]-[Select Line Position] and use the Knob to select a vertical line.
- Control range varies according to the resolution of the input SDI signal.
 - * PAL : Min 17, Max 522
 - * NTSC : Min 23, Max 623
 - * 720p : Min 26, Max 750
 - * 1080i : Min 21, Max 1123
 - * 1080p : Min 42, Max 1121
- Control range for HDMI/Analog signal varies according to the output resolution of the signal.
 - * Min 0, Max 800

● Luma(Y') Zone Check

- Displays the Luma(Y') level of the input image in colors.
- May select between [Color Pattern] or [Zebra Pattern].
- Each pixel's Y' analyzed and changed to a certain color or zebra pattern according to the Index on the right side of the screen.
- When a pixel's Y' level is under 0%(16), the color / diagonal line will be colored Green.
- When the pixel's Y' level is over 100%(235), the color / diagonal line will be colored Red.
- When the Y' level of a pixel is between 0~100%, the pixel is displayed with Gray, except for selected Luma Zone.
- In the [Color Pattern] mode, a 5% zone of the selected Y' level will be colored Pink(5%) and $\pm 10\%$ will be colored Yellow(-10% from Pink) and Cyan(+10% from Pink).
- In the [Zebra Pattern] mode, $\pm 5\%$ of the selected Y' Level will be displayed with diagonal lines.

● Luma(Y') Zone Adjust

- Used to set the Y' level to be colored Yellow, Pink and Cyan in [Color Pattern] mode, or to set Y' level zone to be displayed with diagonal lines in [Zebra Pattern] mode simply by scrolling the Knob.
- Available values are 0 ~ 100%.
- * See section "Other Function [6] Luma(Y') Zone Check" on page 25 for more information.

6. Menu Operations

[5] Waveform / Level Check (VFM-056WP Only)



• Range Error (VFM-056WP Only)

- Used to set whether or not to activate Y MAX, Y MIN, C MAX, C MIN, Y PICTURE BLINK and C PICTURE BLINK functions.
 - The values of Y MAX, Y MIN, C MAX, C MIN are indicated in Waveform/Vectorscope.
 - If [Y PICTURE BLINK] or [C PICTURE BLINK] is enabled, the section of image that exceeds the selected values of Y MAX, Y MIN, C MAX and C MIN shall blink.
- * See section "Other Function [8] Range Error" on page 26 for more information.

• Y Max

- Used to set the maximum luma(Y') level from 0 to 255.
- Pixels with values exceeding the max Y' level will blink in the screen, and displayed as red on the Waveform.

• Y Min

- Used to set the minimum luma(Y') level from 0 to 255.
- Pixels with values exceeding the min Y' level will blink in the screen, and displayed as red on the WaveForm.

• C Max

- Used to set the maximum chroma(C') level from 0 to 255.
- Pixels with values exceeding the min C' level will blink in the screen, and displayed as red on the Waveform.

• C Min

- Used to set the minimum chroma(C') level from 0 to 255.
- Pixels with values exceeding the min C' level will blink in the screen, and displayed as red on the Waveform.

• Y Picture Blink

- Used to set whether or not to blink pixels with values exceeding Y MAX and Y MIN.

• C Picture Blink

- Used to set whether or not to blink pixels with values exceeding C MAX and C MIN.

• Wave/Vector 2x Gain

- Used to enlarge the Waveform/Vectorscope twice.
- Waveform is enlarged two times the original in the vertical direction, and Vectorscope is enlarged two times in the horizontal and vertical directions.

• 2x Gain Position Adjust

- Used to control and monitor the enlarged part of Waveform/Vectorscope.
- Enlarged Waveform can be move in vertical direction, and Vectorscope in horizontal and vertical direction.

6. Menu Operations

[6] Audio

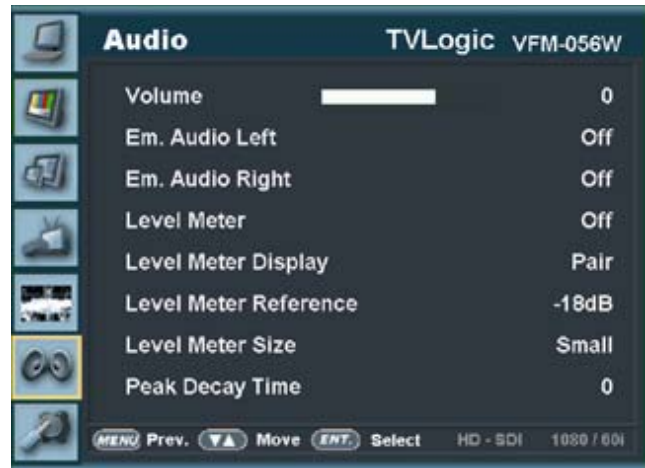

• Audio Volume

- Used to control the output volume for the internal speakers or [AUDIO OUT] on the back of the monitor.
- Control range is from 0 to 30.

• Em. Audio Left/Right

- Used to set embedded audio channel for internal speaker or [AUDIO OUT] terminal on the back of the monitor.
- In SDI mode one of the Off or CH1~CH16 can be selected. In HDMI(HDCP 1.1 Version) mode, Left and Right are set to CH1 and CH2 respectively.
- HDMI(HDCP 1.1 Version) Input: Channel 1 is displayed on the top left and Channel 2 is displayed on the top right.

• Audio Level Meter

- Used to set the Level Meter for the embedded audio.
- Available options are OFF, 16 CH(HOR.) and 16 CH(VER.)
- SDI Input : [Off]-[16CH(Hor.)]-[16CH(Ver.)]
- HDMI Input: [Off]-[2CH(Hor.)]-[2CH(Ver.)]
- * 16 CH(HOR.) : Displays 8 channels on top left and 8 channels on top right of the screen horizontally.
- * 16 CH(VER.) : Displays 8 channels on center left and 8 channels on top right of the screen vertically.

• Level Meter Display (SDI Only)

- Used to set the display method for audio level meter.
- Activates only in SDI mode.
- Available modes are Group and Pair.

• Level Meter Reference

- Display the default audio level meter value, Available options are -18dB and -20dB.
- Audio level meter within selected value turns to green and exceeded audio level is displayed in yellow.
- Audio level exceeding -4dB is displayed in red.

• Level Meter Size

- Used to control the size of the audio level meters.
- Available options are NORMAL and LAGRE.

• Level Meter Decay Time

- Sets the reduction time for max value indication of audio signals.
- Control range is from MIN 0 to MAX 100. Bigger number means a longer display time for max value.

6. Menu Operations

[6] System

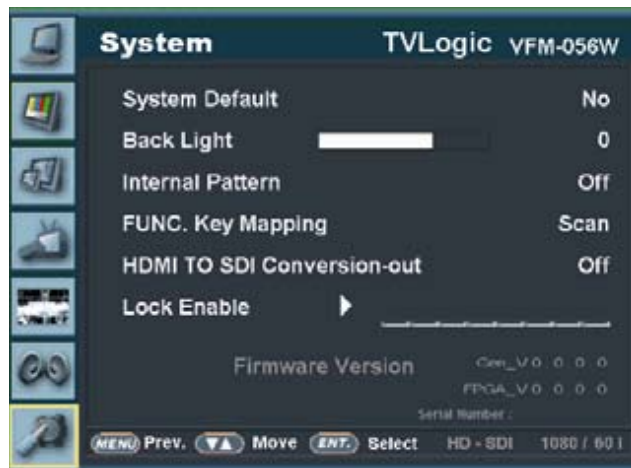
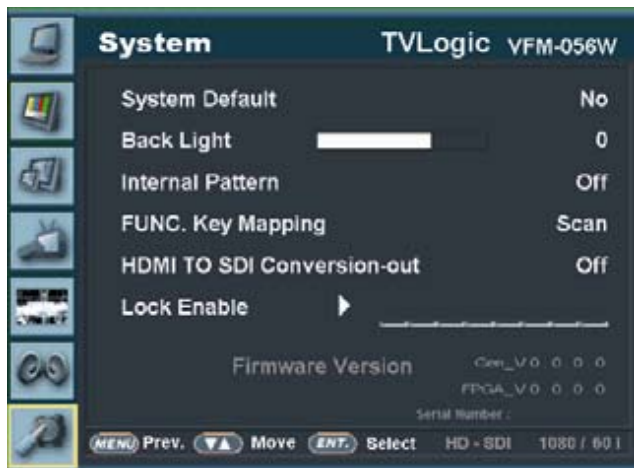

• System Default

- Used to initialize OSD values to factory default.

• Back Light

- Used to indicate the backlight level.
- In case of System Default, the value returns to factory default(after color calibration).
- Available values are from 0 to 50.

• Internal Pattern

- Generates ColorBar, Pludge and Grayscale Pattern internally.
- Selectable range for Gray Pattern is from 0% to 100% with 5% increment.

• FUNC. Key Mapping (VFM-056WP Only)

- Used to assign a function to [Func.] button.
- Selectable Functions: [Scan],[Aspect],[Marker],[H/V Delay],[Blue Only],[MaxBright],[Zoom],[TimeCode],[Audio Level M.],[Focus Assist],[WaveForm*],[Range Error*],[Luma Zone*],[DSL R SCALE] and [Freeze].
- Functions above are activated after pressing the [● FUNC./● FUNC. SEL.] button on the back of the monitor for more than 2 seconds.

• HDMI To SDI Conversion-Out

- Video source from 'HDMI input' terminal can be output through 'SDI throughout' terminal.
- Available Input formats are 59.94i/p, 60i/p and 50i/p.
- Available Output formats are 1280x720 59.94p/60p/50p.

• Lock Enable

- Input enable code to upgrade from Standard model to Premium model.

• Firmware Version

- Displays current firmware version.

• Serial Number

- Displays the serial number of the monitor.

7. Button Functions

[1] Video Input



- VFM-056W / VFM-056WP supports various input signals.

1. Press the [● MENU<EXIT>/ ● SOURCE] button on the back of the monitor for more than 2 seconds and OSD menu is activated as follows.
2. Input signal information is displayed at the bottom of the OSD menu.
3. Press [● MENU<EXIT>/ ● SOURCE] button again to remove the OSD menu from display.

If no image is displayed after selecting the desired input mode, check and make sure that connection is not lose or disconnected.

[2] Function Key Set Button



- Used to make a quick setting of the Function Key.

1. Press the [● FUNC./ ● FUNC. SEL.] button on the back of the monitor for more than 2 seconds and activate the OSD menu as follows.
Move to desired function and press [ENTER] button to select.
2. Once the function is set, press the [● FUNC./ ● FUNC. SEL.] button to activate the function.

8. Other Functions

[1] Pixel to Pixel



- * VFM-056W / VFM-056WP monitors provide pixel count info using Pixel to Pixel mode.
- * Select [Scan] mode in the OSD menu by pressing the [● FUNC. ● FUNC. SEL.] button to activate the [Pixel To Pixel] mode.
- * After activation of [Pixel To Pixel] mode, use the Knob to move the position.

| Input | Action | Available Modes |
|---------|-----------------------------------|--|
| HD 720p | [Scroll UP] (Clockwise) | Center -> Left Top -> Right Top -> Right Bottom -> left Bottom -> Center -> ... |
| | [Scroll DOWN] (Counter clockwise) | Center -> Left Bottom -> Right Bottom -> Right Top -> Left Top -> Center -> |

Pixel to Pixel mode is not available for Graphic Signal input.

Pixel to Pixel mode works for SD signal, when the input resolution is lower than the monitors native resolution.

• Positions in HD Signal 1080i/1080p mode

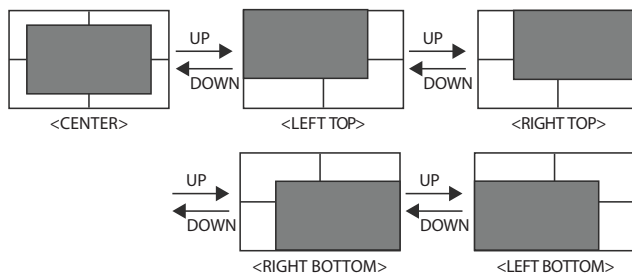

8. Other Functions

[2] User Aspect



- Select [Aspect] mode in the OSD menu by pressing the [● FUNC./● FUNC. SEL.] button to activate the [User Aspect] mode.
- After activation, press the Knob to get ready for controlling.



- Adjust the ratio using the Knob.
- Control range for width
VFM-056W : Min[100] ~ Max[1280]
- Control range for height
VFM-056W : Min[100] ~ Max[800]
- The size-adjusted picture always stay in the center of the screen.

To adjust the 16:9 aspect ratio of 1920X1080 resolution into 2.35:1 aspect ratio, adjust the width and height as 1280 x 544.

8. Other Functions

[3] Waveform / Vectorscope (VFM-056WP Only)

• Waveform Y

- Displays the Luma(Y') component of the input signal into waveform.

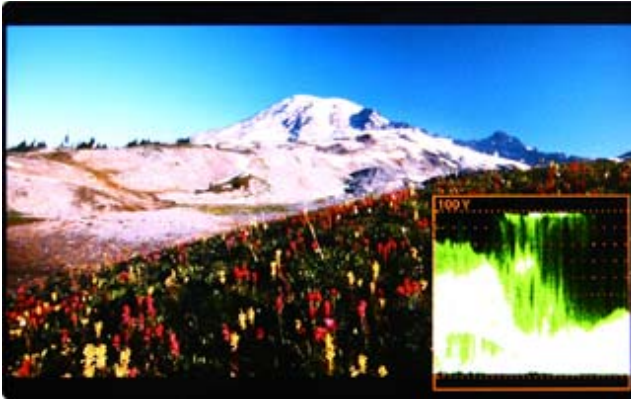

• Waveform Cb, Cr

- Displays the Cb, Cr components of the input signal into waveform.

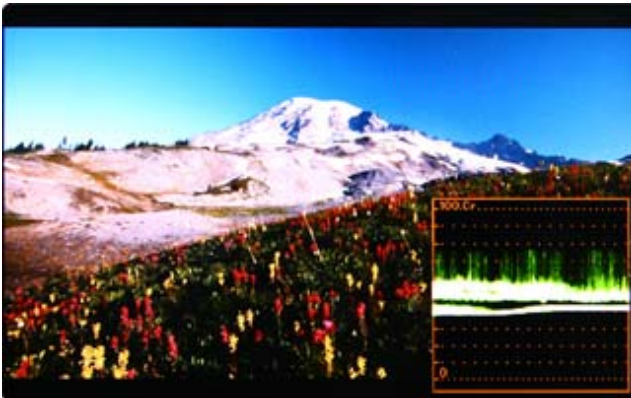
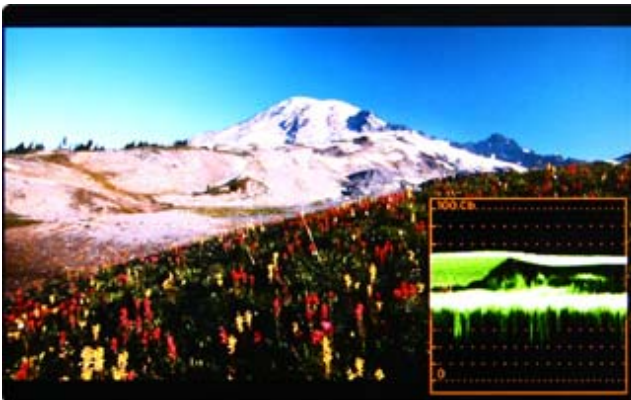

• VectorScope

- Displays the color components 'B-Y' and 'R-Y' of the input signals onto the X-Y axis.
- Two different types of Vectorscopes are displayed according to SD or HD input signals.
- 100% and 75% scales are indicated on the Vectorscope.

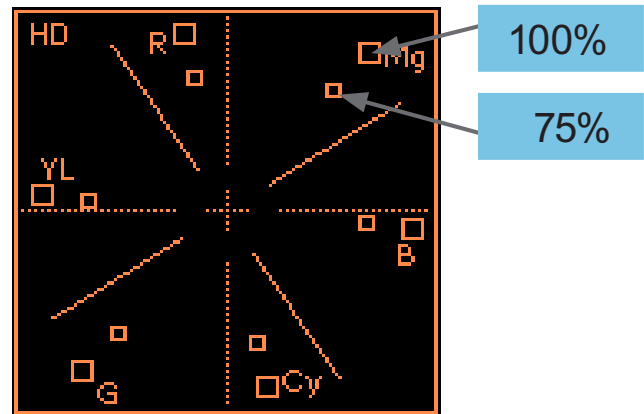
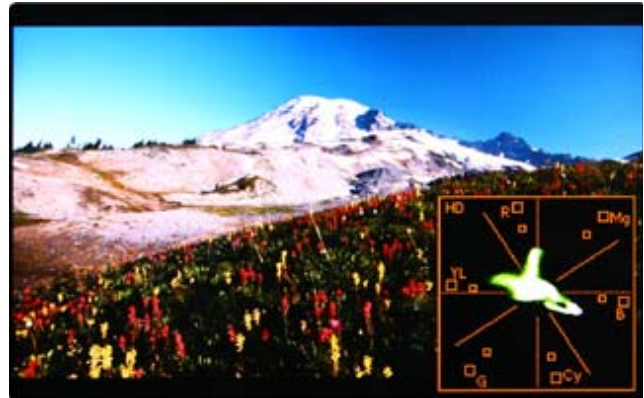

8. Other Functions

[4] Line Select (Waveform/VectorScope)

- **VFM-056WP Only**
- Used to select specific Vertical Line for WaveForm/VectorScope.
- It is available when LINE WaveForm is activated.
- To activate this feature, go to [WFM/LevelCHK]-[WaveForm/Vector]-[Select Line Position] and use the Knob to select a vertical line.
- Control range varies according to the resolution of the input SDI signal.
 - * PAL : Min 17, Max 522
 - * NTSC : Min 23, Max 623
 - * 720p : Min 26, Max 750
 - * 1080i : Min 21, Max 1123
 - * 1080p : Min 42, Max 1121
- Control range for HDMI/Analog signal varies according to the output resolution of the signal.
 - *Min 0, Max 800

* Selected line is indicated on the screen.



[5] Zoom

- Used to magnify the input signal from 0% to 90%.
- Supports Zoom Width Scroll / Zoom Height Scroll function.
- Zooms IN/OUT focused on the scrolled area.

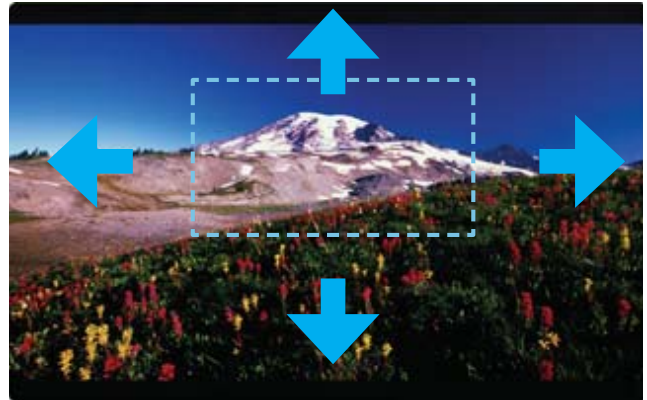

<ZOOM OFF>

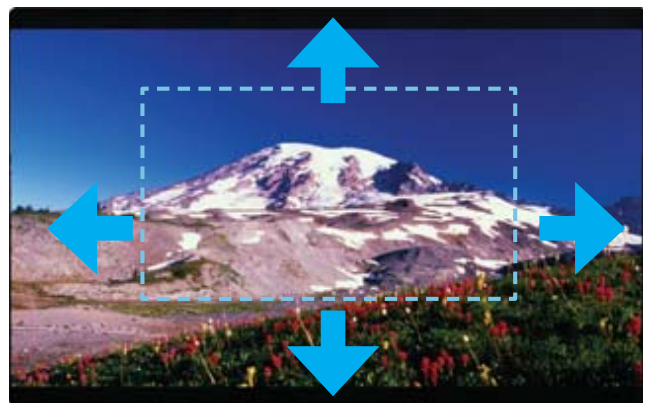

<ZOOM 50%>



<ZOOM 75%>

8. Other Functions

[6] Luma(Y') Zone Check (VFM-056WP Only)

■ Color Pattern Type

- Displays the Luma(Y') level of the input image in colors.
- $Y' \geq 100\%$: Pixels with higher Y' level than 100 turn to red.
- $Y' \leq 0\%$: Pixels with lower Y' level than 0 turn to green.
- Pixels with Y' levels designated by the user are displayed as following colors - yellow, pink, cyan.
- Factory Default Y' (Border line between pink and yellow) level is 75% and pink color is assigned to pixels with Y' level from 70% to 75%.
- Yellow color is assigned to pixels with Y' level from 75% to 85%, and Cyan from 60% to 70%.
- This function is designed for better performance in setting the exposure of lighting when shooting with vDSLR cameras.



<Luma Zone Check OFF>



<Luma Zone Check ON_Color Pattern Type>

■ Zebra Pattern Type

- Displays the pixels with designated Luma(Y') levels with zebra pattern.
- $Y' \geq 100\%$: Pixels with Y' level over 100% turn to red diagonal line.
- $Y' \leq 0\%$: Pixels with Y' level under 0% turn to green diagonal line.
- User defined Y' levels are displayed as black diagonal line.
- Factory Default Y' level is 70% and the pixels with Y' level from 65% to 75% is displayed with zebra pattern
- Pixels with 10% of Y' level is displayed as black diagonal line.
- This function is designed for better performance in setting the exposure of lighting when shooting with vDSLR cameras.



<Luma Zone Check ON_Zebra Pattern Type>

8. Other Functions

[7] Focus Assist

- Focus Assist function assigns a color to the pixels in the shape or boundary area of the image to inform the user to make the best focus.
- With this function, user can easily differentiate the focused area from out-focused area especially shooting with shallow depth of field.
- Available types are [Mono] and [Color] types.
* [Mono] : Background image is mono type.
[Color] : Background image is original color type.



<Focus Assist OFF>



<Focus Assist ON>



<Focus Assist ON>

[8] Range Error (VFM-056WP Only)

- Pixels with Y' or C' levels exceeding the designated levels of Y MAX, Y MIN, C MAX and C MIN shall blink.
- Analyzes the input signal's Luma(Y') and chroma information(C') and if the input signal exceeds the designated minimum value and maximum value, the pixel shall blink. This function is to help the user to easily find out any unwanted level of signals and for better exposure setting.



<Range Error OFF>



<Range Error ON>

8. Other Functions

[9] DSLR Scale

- This function is designed for some DSLR cameras (Canon 5D, 550D and Nikon D7000) that output different resolution from the operation mode (preview, recording, playback).
- Select the Camera model in the [Display/Vide]-[DSLR Camera Sel.] menu.

■ CANON

- In StandBy mode of Canon 5D Mark II, 1080i of HD resolution is indicated. However, real output resolution is 1620x1080 so blank area is displayed on the screen because the 16:9 aspect ratio is not realized.
- In this case, use DSLR SCALE function to enlarge the 1620x1080 image and display full screen.
- In Recording mode of CANON 5D Mark II, the output resolution is SD(480p).
- Although it is SD, the real output resolution is 640x390 not 720x480.
- DSLR SCALE function scales the 640x390 image to 1280x800 (panel resolution) and display full screen.

※Note

1. When you compare the circle chart or the camera shooting chart with DSLR connected monitor (HDMI) and HDMI to SDI Conversion connected monitor, The function of Live/Rec 16:9 mode should be selected to compare circle and it is equal to its actual. If the circle is compared in Live/Rec Full mode, the output of the circle is deformed.
2. Both VFM-056WP connected DSLR and VFM-056WP connected HDMI to SDI Conversion should be compared to circle in Zeroscan mode. It is deformed if user selects in Overscan and Underscan mode.

■ NIKON

- In StandBy/Record mode of NIKON, actual resolution of the output signal from HDMI terminal is 952x634, failing to display 16:9 aspect ratio and making marginal blank area. Activating DSLR SCALE function will scale the 952x634 raster image to fill the full screen.



<DSLR Scale OFF>



<DSLR Scale ON>

8. Other Functions

[10] HDMI To SDI Conversion-Out (VFM-056WP Only)

- Video source from 'HDMI input' terminal can be output through 'SDI throughout' terminal.
- HDMI Input Signal formats are 59.94 i/p, 60 i/p and 50 i/p.
- SDI Output Signal formats are 1280x720 59.94p/60p/50p. (Differs depending on Input V Freq.)

※Note: HDSLR camera manufacturers usually specify the resolution and frame rate for the recording. The signal format that is output through HDMI terminal of cameras may differ from makers to makers. The signal format for HDMI output and playback function of Canon HDSLRs is 59.94i. And even though 60i or 60p is specified in the specification of the cameras, the actual recording or HDMI output format would be 59.94i or 59.94p.

| Input (HDMI) | Output(SDI) |
|---|-----------------|
| 720x480 59.94i 720x480 59.94p 1280x720 59.94p 1920x1080 59.94i 1920x1080 59.94p | 1280x720 59.94p |
| 720x480 59.94i 720x480 59.94p 1280x720 59.94p 1920x1080 59.94i | 1280x720 60p |
| 720x576 50i 720x576 50p 1280x720 50p 1920x1080 50i 1920x1080 50p | 1280x720 50p |

- Activate the HDMI TO SDI Conversion-out function and press the [Enter] button.
- Then "Turn off/on POWER" message will be displayed.

Turn off/on POWER!!

- After turn off and turn on the power, the HDMI-to-SDI Conversion-Out function will be activated.
- When the HDMI To SDI Conversion-Out function is activated, the Active Area of monitor and SDI output screen will be downscaled and be displayed as 1226(H) x 690(V) Resolution.

<HDMI To SDI Conversion-out OFF>



(Active Area : 1280x720)

<HDMI To SDI Conversion-out ON>



(Active Area : 1226x690)

8. Other Functions

[11] Screen TALLY

- **Screen TALLY On/Off**
 - Used to set Tally operation according to the input level of TALLY IN terminal which is among the terminals of XLR 4P connector in the rear.
- **Screen TALLY Operating Level**
 - Used to set the input level of Tally operation. (Open&Low : less than 0.6V, High : more than 2.5V)
 - High: Set the level as "High" to activate the Tally and set the level as "Low" to inactivate the Tally.
 - Low: Set the level as "Low" to activate the Tally and set the level as "High" to inactivate the Tally.
- **Screen TALLY Color**
 - Used to set Tally color.
 - Available colors are Red, Green and Yellow.



<Screen TALLY On>

[12] Internal Pattern

- Displays internally generated test patterns.
- The pattern consists of ColorBar and Pluge+ Grayscale Patterns. Full screen colors of various gray levels(0~100%) are also embedded.

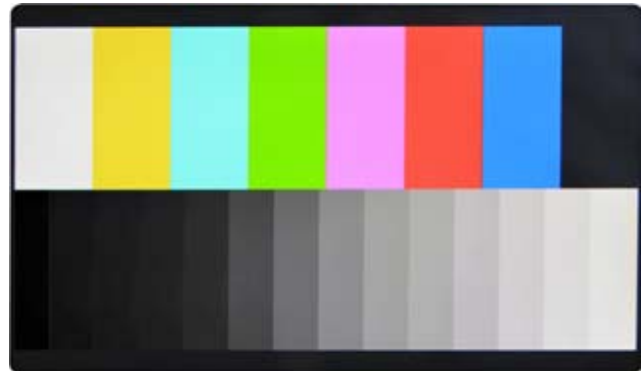

<Color Bar + Pluge Pattern>



<Gray Pattern>

9. Product Specifications

| | | VFM-056W / VFM-056WP |
|--------------------------------|--|--|
| LCD | Size | 5.6" |
| | Resolution | 1280 X 800 (16:10) |
| | Pixel Pitch | 0.0945(H) X 0.0945(W) mm |
| | Color Depth | 16.7M (6bit + Dithering) |
| | Viewing Angle | H : 170 degrees / V : 170 degrees |
| | Luminance of white | 300 cd/ m ² (Center) |
| | Contrast Ratio | 500 : 1 |
| | Display Area | 120.96(H) X 75.60(V) mm |
| Input Connector | 3 X RCA | Analog Input |
| | 1 X BNC | 1X 3G-SDI Channel Input |
| | 1 X HDMI | HDMI Input |
| Output | 1 X BNC | SDI Channel (Active Loop Through) |
| Input Signal | Analog | Composite Video / S-Video / Component Video |
| | * 3G-SDI (VFM-056WP) | 2.970Gbps |
| | HD-SDI | 1.485Gbps |
| | SD-SDI | 270 Mbps |
| | HDMI | 480i / 480p / 720p / 1080i & VESA / IBM Modes |
| Analog Input Spec | Composite | 1.0Vpp (with Sync) |
| | S-Video | 1.0Vpp (Y with Sync), 0.286Vpp(C) |
| | Component | 1.0Vpp (Y with Sync), 0.7Vpp (Pb,Pr) |
| SDI Input Signal Formats | * SMPTE-425M-A/B (VFM-056WP) | 1080p(60/59.94/50/30/29.97/25/24/23.98/30sF/29.97sF/25sF/24sF/23.98sF) 1080i(60/59.94/50) |
| | SMPTE-274M | 1080i (60/59.94/50) 1080p (30/29.97/25/24/24sF/23.98/23.98sF) |
| | SMPTE-296M | 720p (60/59.94/50) |
| | SMPTE-260M | 1035i (60/59.94) |
| | SMPTE-125M | 480i (59.94) |
| | ITU-R BT.656 | 576i (50) |
| Audio In | Embedded Audio | |
| Audio Out | Analog Stereo (Phone Jack), Internal speaker (Mixed Mono) | |
| Power | DC 6~12V | |
| Power Consumption (Approx.) | 9.6 Watts(Typ.) | |
| Operating Temperature | 0°C to 45°C (32°F to 113°F) | |
| Storage Temperature | -20°C to 60°C (-4°F to 140°F) | |
| Main Body Dimensions (mm/inch) | 156 X 103 X 31 (10.63 X 4.05 X 1.22) | |
| Box Dimensions (mm/inch) | 225 X 155 X 128 (8.85 X 6.10 X 5.03) | |
| Weight | 0.3Kg / 0.66 lbs | |
| Basic Accessories | DC Power adapter, AC Power Cord, BNC Connector (Angle Type), Camera Mount | |
| Optional Accessories | Carrying Case, Sun-Hood, External Acylic Filter, Tripod Ball Head, Battery Bracket | |

* Only available with VFM-056WP model.

- The specification above may be changed without notice.

10. Optional Accessories



Sun-Hood



External Acrylic Filter



Carrying Case



V-Mount



Tripod
Ball Head



Camera Mount
Support



Hot shoe



Battery Bracket



Battery Bracket-2EA



Battery Bracket

* battery Brackets

- BB-056S (SONY : NF-F770/970)
- BB-056U (SONY : BP-U30/U60)
- BB-056C (CANON : BP930/945/970G)
- BB-056E (CANON : 5D/7D)-2EA
- BB-056P (PANASONIC : D28S/54S)
- BB-056B (PANASONIC : AF-100)-2EA
- BB-056AA (AA)

TVlogic Always **ON-AIR**

FOR MORE INFORMATION PLEASE VISIT : <http://www.tvlogic.tv>
12F, ACE HIGH-END 8, 345-4 Gasan-dong, Geumcheon-gu, Seoul, 153-802, KOREA
TEL : +82-70-8668-6611, FAX : 82-2-6123-3201, E-mail : sales@tvlogic.co.kr