

Marshall Electronics

V-LCD70XP-3GSDI

7" High Resolution Field Monitor

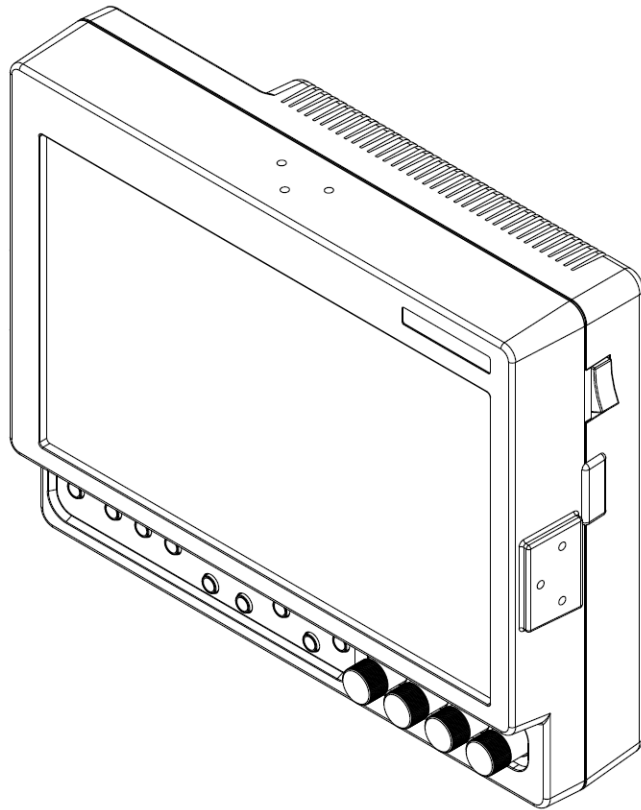

Operating Instructions

This page intentionally left blank.

Contents

Product Overview	4
Features	4
Installation and Initial Setup	5
Unpacking	5
Mounting	5
Changing the Battery Adapter	5
Connections and Power-On	5
Front and Side Panel Features	6
Power Button	6
Input Select Buttons	6
User-Definable Function Buttons	6
Menu Navigation Buttons	6
Image Adjustment Knobs	6
Power Switch	6
Service Connector	6
Rear Panel Features	7
Component and Composite Input and Output	7
3G-SDI Input Connector	7
Power Input	7
Battery Adapter	7
1/4-20 Mounting Hole	7
Compatible Input Formats	8
On-Screen Menu	9
STRUCTURE OVERVIEW	9
MAIN MENU AND NAVIGATION	9
VIDEO CONFIGURATION SUBMENU	10
<i>Color Temperature Presets</i>	10
<i>Gamma Correction</i>	10
<i>RGB Bias and Gain</i>	10
<i>Check Field</i>	11
<i>Aspect Ratio Setting</i>	11
<i>Pixel-to-Pixel Mode</i>	11
<i>H/V Delay</i>	12
<i>Underscan</i>	12
<i>NTSC Black Level</i>	12
MARKER CONFIGURATION SUBMENU	12
<i>Marker Enable</i>	13
<i>Center Marker</i>	13
<i>16:9 Markers</i>	13
<i>4:3 / Full Screen Markers</i>	13
<i>Marker Background</i>	14
<i>User Markers</i>	14
FILTER CONFIGURATION SUBMENU	15
<i>False Colors</i>	15
<i>Peaking Filter (Focus Assist)</i>	16
<i>Mosquito Filter</i>	16
SYSTEM CONFIGURATION SUBMENU	16
<i>Input Format OSD</i>	16
<i>Curtain Color</i>	16
<i>Splash Screen</i>	17
<i>Contrast/Backlight</i>	17
<i>Freeze Input</i>	17
<i>Image Flip</i>	17
<i>Manufacturer Default</i>	17
Function Presets Submenu	17
<i>User-Definable Function Buttons</i>	17
Specifications	18
Maintenance	19
Warranty Information	20

Product Overview

The V-LCD70XP-3GSDI is a 7.0" high-definition widescreen LCD monitor featuring our completely digital TFT-MegaPixel active matrix LCD platform. With built-in focus assist and false color filters, this monitor is ideal as a light-weight high resolution viewfinder or focus-assist monitor. Our proprietary digital signal processing features 10-bit A/D conversion of all analog signals, with 4X over-sampling and 5-line super-adaptive 2D comb filtering of composite signals. De-interlacing is performed using our HyperProcess algorithm with motion adaptive interpolation. Multi-format compatibility accommodates virtually all video formats including NTSC/PAL, 480i/p, 720p, 1080i/p. The 3G-SDI input supports *Triple Rate* 3G/HD/SD video signals. Adjustable color temperature enables the most precise color representation possible. Advanced features include aspect ratio settings, a variety of screen markers, underscan mode, blue-only mode, monochrome mode, H/V delay, Pixel-to-Pixel mode, and 3G-SDI Input Format selection.

Features

■ High-Resolution 7.0" Widescreen Panel

The V-LCD70XP-3GSDI features an all-digital TFT-MegaPixel active matrix LCD system with 1.2 million pixels. The LCD panel features a brightness of 450 cd/m² and a contrast ratio of 600:1 making the display ideal in a variety of environments and lighting conditions.

■ Multi-Format Compatibility

The V-LCD70XP-3GSDI accommodates many video standards with **Composite Video, YPbPr and 3G-SDI** inputs. Accepted formats include NTSC/PAL, 480i/p, 576i/p, 720p, 1035i, 1080i, as well as 3G formats including 1080p-60.

■ End-to-End Digital Signal Processing

Analog input signals are digitized using an advanced 10-bit process with 4x over-sampling, 5-line super-adaptive 2D comb filtering, and exacting color space conversion. Video is scaled to fit on the screen in the highest possible resolution using a state-of-the-art LSI that incorporates precision gamma correction and our HyperProcess motion adaptive interpolation for interlaced images.

■ ColorMatch Conversion with Color Temperature Adjustment

Emulation of SMPTE-C/EBU color space allows the V-LCD70XP-3GSDI to replace any broadcast CRT monitor. Presets include D55, D65 and D93. Bias and Gain adjustment for each color enables precise color matching and white balance.

■ Focus-Assist, False Color Filter, and other Advanced Features

Focus-Assist, False Color filter, Aspect ratio settings, underscan mode, blue-only mode, monochrome mode, and H/V delay are a few of the advanced features which make the V-LCD70XP-3GSDI at home in any broadcast environment. The 3G-SDI Input allows display of incoming SDI, HD-SDI and 3G formats in the 4:2:2 YUV or 4:4:4 RGB color space. Pixel-to-Pixel mode also allows native display of any incoming image format.

■ Adjustable Screen Markers

A variety of screen markers in 4:3, 16:9, and full screen modes allow accurate monitoring of the different aspect ratios used in broadcast environments. User Markers allow for custom aspect ratio, cropping framing, etc.

■ Image Flip

Vertical image flip allows for flexibility in mounting the monitor in many positions.

■ User-Definable Function Buttons

Four user-definable function buttons on the front-panel allow quick access to numerous settings and features including focus-assist, false color filter, aspect ratio, screen markers, monochrome mode, color temperature, delay mode, and more.

■ User-Interchangeable Battery Adapters

Several battery adapter options accommodate a wide variety of professional batteries and camcorder batteries.

Installation and Initial Setup

■ Unpacking

Carefully unpack the V-LCD70XP-3GSDI monitor and verify that the following items are included:

- V-LCD70XP-3GSDI Monitor
- V-PS12-5V-XLR Power Supply with 4-Pin Female XLR Connector
- Operating Instructions

Inspect the unit for any physical damage that may have occurred during shipping. Should there be any damage, immediately call Marshall Electronics Customer Service at (800) 800-6608. If you are not located within the continental United States, call +1 (310) 333-0606.

■ Mounting

The V-LCD70XP-3GSDI monitor features a ¼"-20 mounting hole on the underside of the enclosure, allowing the monitor to be mounted to a camera or other device using a variety of mounts. There are additional locations on the side and top for optional threaded inserts. Contact your dealer, or visit www.lcdracks.com for more information.

■ Changing the Battery Adapter

The V-LCD70XP-3GSDI ships with a single battery adapter, specified at the time of ordering. Several other battery adapters are available to accommodate a variety of batteries.

- Many different user-interchangeable "camcorder battery" adapters are available: **Canon**, **Panasonic**, **JVC**, **Sony BP**, **Sony NP-Q**, and **Sony NP-F**.

Installation: To uninstall one of the above battery adapters, remove the 5 screws on the adapter. Remove the adapter and carefully disconnect the 4-pin connector between the monitor and adapter. To install one of the above battery adapters, connect the 4-pin connector of the new battery adapter to the monitor, and re-install the 5 screws.

Note: Do not change the pinout of the 4-pin connector on the battery adapter. This pinout is factory-configured according to each battery adapter.

- **IDX** and **Anton Bauer** battery adapters are also available. Installation can easily be performed in the field. Contact Marshall Electronics Customer Service at (800) 800-6608 for further information.

■ Connections and Power-On

Plug the V-PS12-5V-XLR power supply into an AC power source (100-240 V @ 50/60 Hz). Attach the 4-pin female XLR connector to the back of the monitor. Please note that 12VDC can be also supplied directly to the monitor from a variety of sources. The monitor will draw no more than 1.0 Amps at 12 Volts in operation (12 Watts).

Connect the required cables for video signal input and output. (Power must be applied to the V-LCD70XP-3GSDI for the active loop-through outputs to be activated.) All BNC connectors are rated at 75Ω.

The unit defaults to 'ON' when power is supplied. Video will automatically be detected and displayed on the screen.

Front and Side Panel Features

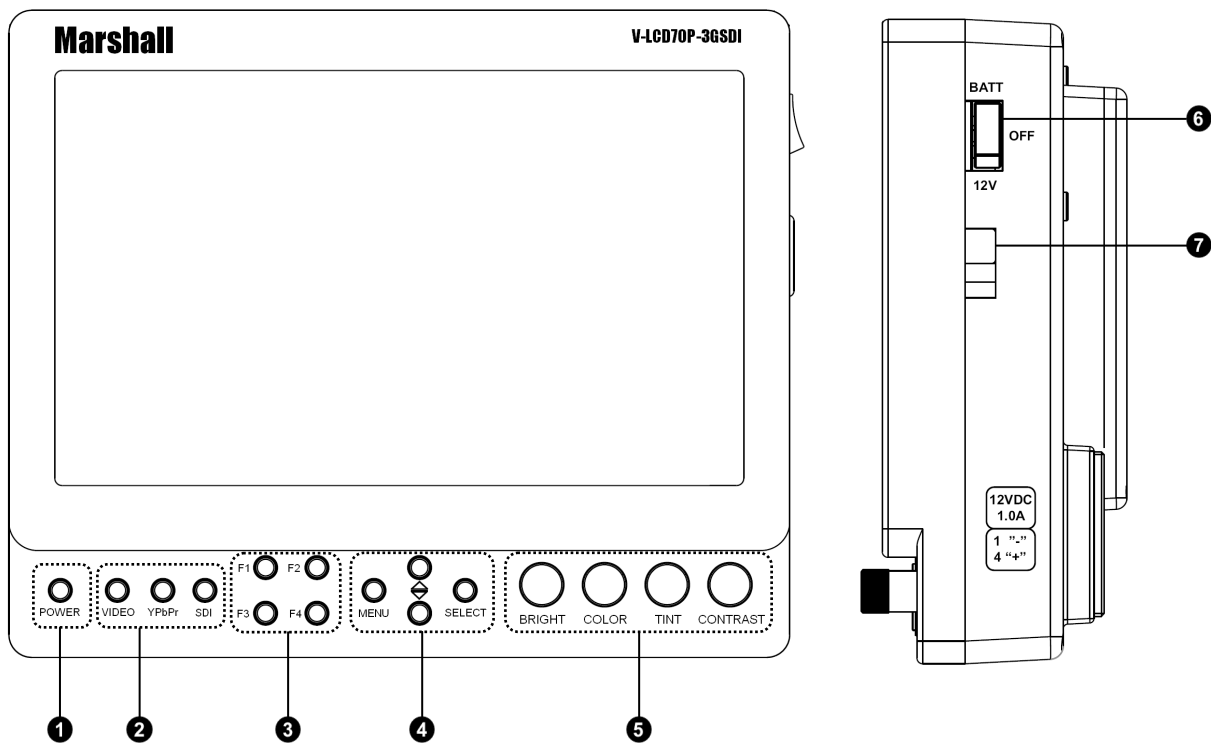

1 Power Button

Use the power button to toggle between ON and STANDBY modes. In the STANDBY state, the LED on the button will illuminate bright green. In the ON state, the LED will dimly illuminate green.

2 Input Select Buttons

Use the VIDEO, YPbPr, and SDI buttons to select the corresponding analog or digital input. Video standards (NTSC/PAL, etc.) are automatically detected.

3 User-Definable Function Buttons

Four user-definable function buttons can be used for direct access to various settings. Functions are assigned using the on-screen menu (See **User-Definable Function Buttons – Page 17**).

4 Menu Navigation Buttons

Use the Menu, ▲, ▼, and **Select** buttons to display and navigate the on-screen menu (See **Main Menu and Navigation – Page 9**).

5 Image Adjustment Knobs

Use the image adjustment knobs to adjust color saturation, brightness and contrast of the image. The status of each image adjustment parameter is shown on the bottom left of the screen, with values ranging from 0 to 100. Default value is 50.

6 Power Switch

Use the hard power switch to supply power to the monitor, and choose the input from which the monitor draws power. The upper switch position uses the battery adapter, the lower switch position uses the XLR input, and the center position is OFF. Battery life can be preserved by setting this switch to the OFF position when the monitor is not in use.

7 Service Connector

This connector is for factory and future use.

Rear Panel Features

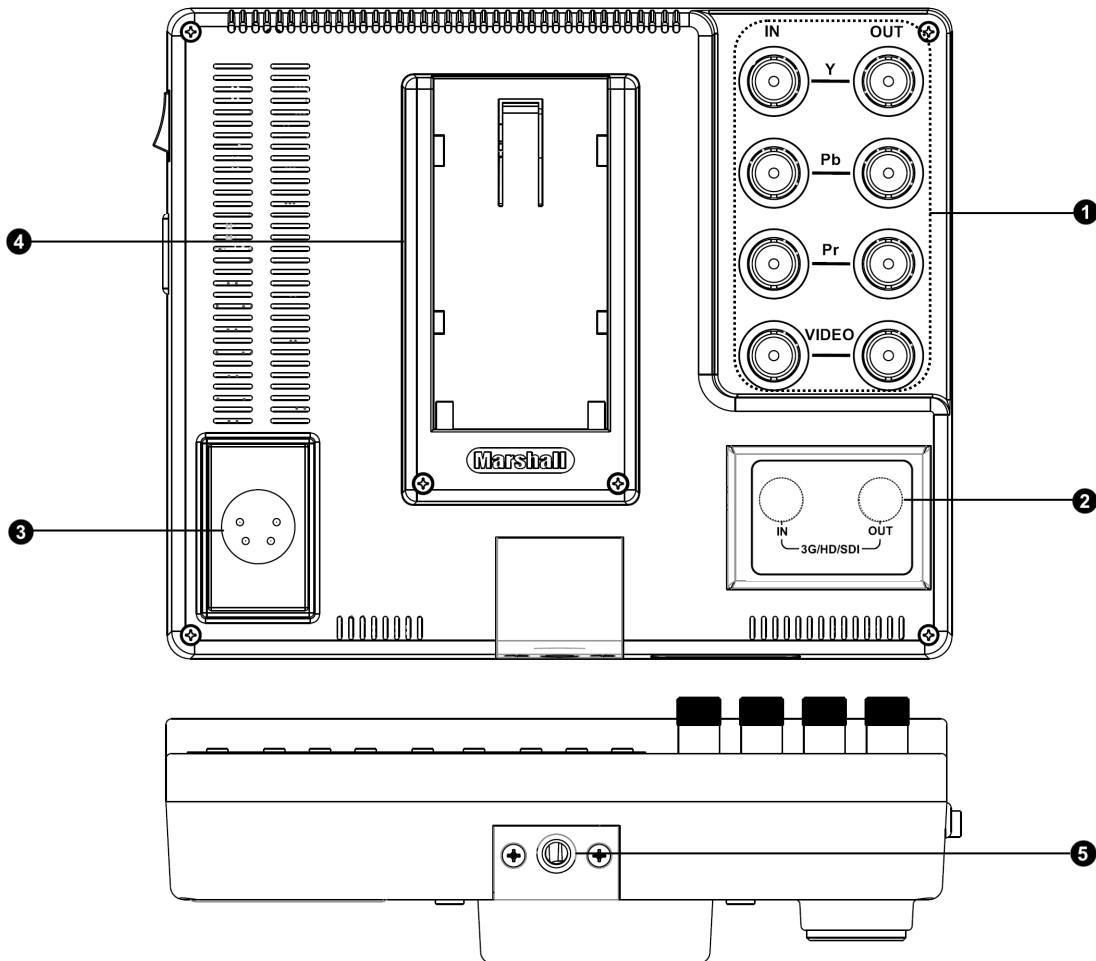

1 Component and Composite Input and Output

The V-LCD70XP-3GSDI has HD component (YPbPr) and composite input. There is an active loop-through output for each analog input. See page 8 for supported video formats. The BNC inputs are internally terminated with 75 ohms.

2 3G-SDI Input Connector

Connect Serial Digital Sources here. Accepted input formats can be found on page 8.

3 Power Input

Connect 12VDC to the 4-Pin XLR power input connector. Power can be supplied from the included power supply, or from a variety of DC sources supplying at least 1 Amp at 12 Volts.

IMPORTANT: If using a power source other than the included power supply, be sure that the polarity of the DC input is correct:

- Pin 1: GND
- Pin 2: N/C
- Pin 3: N/C
- Pin 4: +12VDC

4 Battery Adapter

The V-LCD70XP-3GSDI can be powered from a variety of batteries. Several user-interchangeable battery adapters are available. See your dealer, or www.lcdracks.com for available adapters.

5 1/4-20 Mounting Hole

Use the 1/4-20 mounting hole to attach the monitor to a camera or variety of mounting devices.

Compatible Input Formats

Format	Composite	YPbPr	SD/HD-SDI
NTSC	•		
PAL	•		
480i		•	•
576i		•	•
480p / 59.94		•	
576p / 50		•	
720p / 60		•	•
720p / 59.94		•	•
720p / 50		•	•
720p / 30		•	•
720p / 29.97		•	•
720p / 25		•	•
1035i / 60		•	
1035i / 59.94		•	
1080i / 60		•	•
1080i / 59.94		•	•
1080i / 50		•	•
1080psF / 24		•	•
1080psF / 23.98		•	•
1080p / 30		•	•
1080p / 29.97		•	•
1080p / 25		•	•
1080p / 24		•	•
1080p / 23.98		•	•
3G-Formats **			
			3G-SDI
1080p / 60			•
1080p / 59.94			•
1080p / 50			•

** 3G – Level A and B, 4:2:2 and 4:4:4 10 bit modes supported

On-Screen Menu

STRUCTURE OVERVIEW

Main Menu	Video Configuration	Color Temperature	D93, D65, D55, Linear, User
		Gamma Correction	2.2, 2.0, 1.8, 1.6, 2.4
		RGB Bias and Gain	R, G, B Bias (0-100) / R, G, B Gain (0-100)
		Check Field	Off, Mono, Blue, Green, Red
		Ratio	Full Screen, 4:3, 16:9
		Pixel-to-Pixel	Off, On
		H/V Delay	Off, H & V Delay, V Delay, H Delay
		Underscan	Off, On
		NTSC Black Level	7.5 IRE
	Marker Configuration	Marker Enable	Off, On
		Center Marker	Off, On
		16:9 Markers	Off, 4:3, 13:9, 14:9, 1.85:1, 2.35:1, 95% Safe, 93% Safe, 90% Safe, 88% Safe, 85% Safe, 80% Safe, User
		Full Screen Markers	Off, 95% Safe, 93% Safe, 90% Safe, 88% Safe, 85% Safe, 80% Safe, User
		4:3 Markers	Off, 95% Safe, 93% Safe, 90% Safe, 88% Safe, 85% Safe, 80% Safe, User
		Marker Background	100%, 75%, 50%, 25%, 0%
	Filter Configuration	False Colors	Off, On
		Peaking Filter	Off, On
		Mosquito Filter	Off, On
	System Configuration	Input Format OSD	5 sec, On, Off
		Curtain Color	Blue, Black, Green
		Splash Screen	On, Off
		Contrast/Backlight	Contrast, Backlight
		Freeze Input	Off, Freeze
		Image Flip	Off, On
		Manufacturer Default	Select
		Version	<i>(Firmware Version Number Displayed)</i>
	Function Presets	Function on F1	Ratio, Check Field, Image Flip, Mosquito Filter, Peaking Filter, False Colors, Freeze, Aspect Markers, Center Marker, Marker Enable, Underscan, H/V Delay, P-to-P
		Function on F2	Ratio, Check Field, Image Flip, Mosquito Filter, Peaking Filter, False Colors, Freeze, Aspect Markers, Center Marker, Marker Enable, Underscan, H/V Delay, P-to-P
		Function on F3	Ratio, Check Field, Image Flip, Mosquito Filter, Peaking Filter, False Colors, Freeze, Aspect Markers, Center Marker, Marker Enable, Underscan, H/V Delay, P-to-P
		Function on F4	Ratio, Check Field, Image Flip, Mosquito Filter, Peaking Filter, False Colors, Freeze, Aspect Markers, Center Marker, Marker Enable, Underscan, H/V Delay, P-to-P

MAIN MENU AND NAVIGATION

Access the main menu by pushing and holding the **MENU** button on the front panel of the monitor.

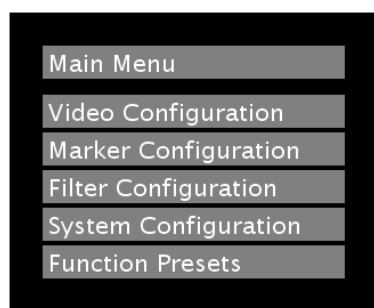

Main Menu

- Step through menu items using the ▲ and ▼ buttons.
- Choose a submenu or select a menu item by pressing **SELECT**.
- Return to the previous menu by pressing **MENU**.
- Exit the main menu by pressing **MENU**. The menu will automatically time out after about 15 seconds.

VIDEO CONFIGURATION SUBMENU

Video Configuration	
Color Temperature	D65
Gamma Correction	2.2
RGB Bias and Gain	Disabled
Check Field	Off
Ratio	16:9
Pixel-to-Pixel	Off
H/V Delay	Off
Underscan	Off
NTSC Black Level	0 IRE

Video Configuration Submenu

■ Color Temperature

Use this setting to choose one of the color temperature presets:

- D55 (5500K)
- D65 (6500K)
- D93 (9300K)
- Linear (no correction)
- USER (Adjustable Color Bias and Gain)

■ Gamma Correction

Use this setting to choose one of the Gamma Correction presets:

- 2.2, 2.0, 1.8, 1.6, or 2.4
- 2.2 is factory default setting

■ RGB Bias and Gain

Select this submenu to fine-tune the monitor's color balance (R, G, B). This should only be done by someone experienced with video engineering, as this will alter the overall color shading of the screen. The purpose is to allow color matching to other types of monitors and/or displays. Note: The Color Temperature preset will automatically switch to USER when Color Bias settings are adjusted. It is normal for color bias adjustments to be very subtle.

When selecting the RGB Bias and Gain submenu, gain adjustment indicators will appear at the top of the screen, and bias adjustment indicators will appear at the bottom of the screen:

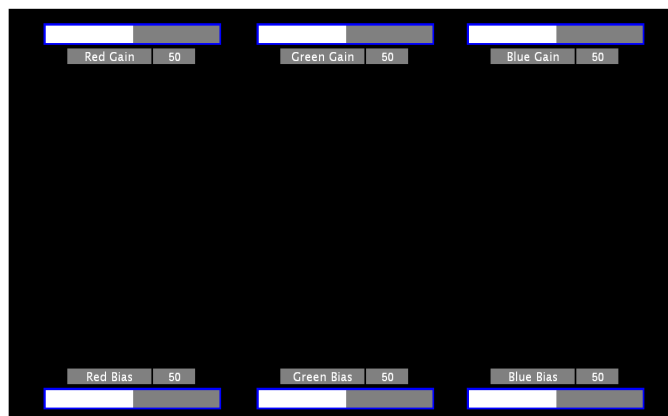

RGB Bias and Gain Submenu

VIDEO CONFIGURATION SUBMENU (Continued)

Use the ▲ and ▼ buttons to select each individual bias or gain control. Press SELECT to begin adjusting the control. Use the ▲ and ▼ buttons to increase or decrease the value.

Alternately, the image adjustment knobs (Brightness, Color, Tint, Contrast) can be used to easily adjust the bias and gain settings as shown below. The knobs affect whichever row of controls (gain or bias) is currently selected.

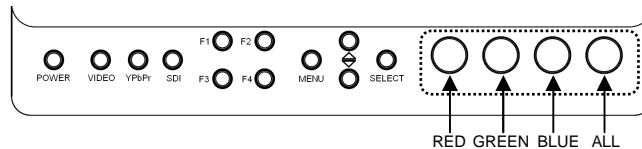

■ Check Field

Use the check field modes for monitor calibration or to analyze individual color components of an image. In **Monochrome** mode, all color is disabled and only a grayscale image is shown. In **Blue**, **Green**, and **Red** check field modes, only the selected color will be shown.

■ Ratio

Use to switch between Full Screen, 4:3 and 16:9 aspect ratios.

As the V-LCD70XP-3GSDI monitor has a native resolution of 800 x 480 RGB pixels, incoming images are automatically scaled to fit the screen:

- In Full Screen, images are scaled to fill the entire screen.
- In 4:3 mode, images are scaled to fill the maximum 4:3 portion of the screen (640 x 480), with black bars filling the remainder of the screen.
- In 16:9 mode, images are scaled to fill the maximum 16:9 portion of the screen (800 x 450), with black bars filling the remainder of the screen.



Full Screen



4:3 Mode



16:9 Mode

Note: The aspect ratio setting is ignored when Pixel-to-Pixel mode is enabled.

■ Pixel-to-Pixel Mode

Use this setting to enable Pixel-to-Pixel mode.

This mode bypasses the monitor's internal scaling function and displays incoming images in their native resolution and aspect ratio, with a one-to-one mapping:

VIDEO CONFIGURATION SUBMENU (continued)

- For incoming formats smaller than the native resolution of the LCD panel (800 x 480), the image will be displayed in the center of the screen using only the necessary LCD pixels. For example, NTSC images will occupy exactly 720 x 480 pixels. The surrounding pixels will be black.
- For incoming formats exceeding 800 x 480 pixels, only the center 800 x 480 of the incoming image will be displayed occupying the whole screen, with the remainder of the picture cropped. For example, 1080i formats will both be cropped to 800 x 480 and displayed full-screen.

Note: Pixel-to-Pixel mode disables aspect ratio control and H/V Delay.

■ H/V Delay (Disabled with Digital Inputs)

Use this setting to enable one of three delay modes (H & V Delay, V Delay, H Delay):

- In H & V Delay mode, both horizontal sync and vertical sync are delayed, resulting in both horizontal and vertical blanking periods being shown on the screen.
- In V Delay mode, vertical sync is delayed so that the vertical blanking period is displayed on screen.
- In H Delay mode, horizontal sync is delayed so that the horizontal blanking period is displayed on the screen.

■ Underscan

Use this setting to enable or disable Underscan mode:

- When Underscan is OFF, the active portion of the video signal is displayed on the screen, with 0% overscan.
- When Underscan is ON, the image size is slightly reduced. This allows the user to clearly view the edges of the active video area.

■ NTSC Black Level

Set the NTSC Black Level according to the type of NTSC composite video input:

- 7.5 IRE: Use this setting for standard NTSC-M signals which use a 7.5 IRE setup (black level).
- 0 IRE: Use this setting for NTSC-J signals which have no setup, or a black level of 0 IRE.

Note: This setting is disabled for PAL composite input and all component/3G-SDI formats.

MARKER CONFIGURATION SUBMENU

Marker Configuration	
Marker Enable	On
Center Marker	Off
16:9 Markers	Off
Full Screen Markers	Off
4:3 Markers	Off
Marker Background	100%

Marker Configuration Submenu

MARKER CONFIGURATION SUBMENU (Continued)

■ Marker Enable

Use this setting to enable or disable all on-screen markers. This setting affects the center marker, full screen markers, 16:9 markers, and 4:3 markers.

■ Center Marker

Use this setting to display a center marker on the screen.

■ 16:9 Markers

Select to superimpose one of markers on the screen when in 16:9 mode.

- 4:3
- 13:9
- 14:9
- 1.85:1
- 2.35:1
- 95% Safe
- 93% Safe
- 90%Safe
- 88% Safe
- 85% Safe
- 80% Safe
- User

16:9 Marker Examples:

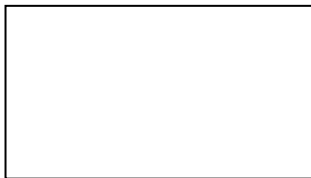

OFF (No Marker)



2.35:1 Aspect Ratio

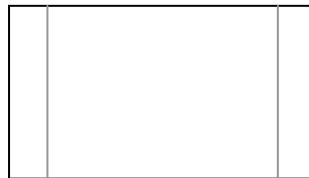

4:3 Aspect Ratio Marker



90% Safe Area

■ 4:3 Markers / Full Screen Markers

Select to superimpose one of the markers on the screen when in 4:3 or Full Screen mode. This setting is disabled when the aspect ratio is set to 16:9, or when Pixel-to-Pixel, Underscan, or H/V Delay is enabled.

- 95% Safe Area
- 93% Safe Area
- 90% Safe Area
- 88% Safe Area
- 85% Safe Area
- 80% Safe Area
- User

4:3 Marker Examples:

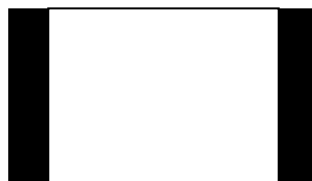

OFF (No Marker)



90% Safe Area

MARKER SETUP SUBMENU (continued)

■ Marker Background

Use this setting to choose how selected markers are blended with the picture on the screen:

- 100% The area masked by the marker is black.
- 75%
- 50% The area masked by the marker is mixed with video picture
- 25%
- 0% No Blend, only edge of marker appears

Example (80% Marker in 4:3 Mode):



■ User Markers

Use this setting to define the size and shape of the on screen marker. To change: choose **User**, then press **Select**. The screen should appear as below. Turn the 4 Knobs to change the Left, Right, Top and Bottom edges of the User Marker.

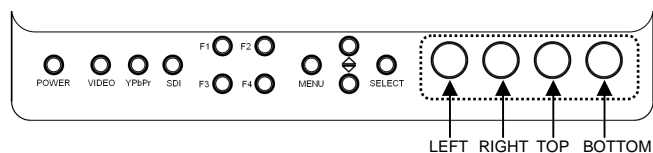
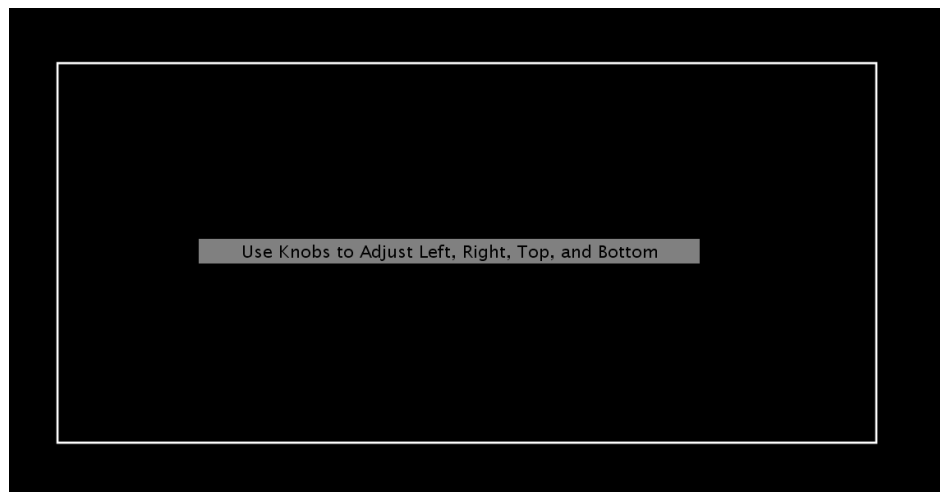

FILTER CONFIGURATION SUBMENU

■ False Colors

This monitor has a false color filter to aid in the setting of camera exposure. As the camera Iris is adjusted, elements of the image will change color based on the luminance or brightness values. This enables proper exposure to be achieved without the use of costly, complicated external equipment. To best utilize this feature, you must understand the color chart below and have a basic understanding of camera exposure. Normally, when shooting subjects like people, it is common practice to set exposure of faces to the equivalent of approximately 56 IRE. The false color filter will show this area as the color PINK on the monitor. Therefore, as you increase exposure (open the IRIS), your subject will change color as indicated on the chart: PINK, then GREY, then a few shades of YELLOW. Over exposed subjects (above 101 IRE) on the monitor will be shown as RED. In addition, underexposed subjects will show as DEEP-BLUE to DARK-BLUE, with clipped-blacks indicated with a FUCHSIA-like color. Lastly, the color GREEN is used to indicate elements of the image that are approximately 45 IRE. This represents a 'neutral' or 'mid-level' exposure commonly used for objects (not people).

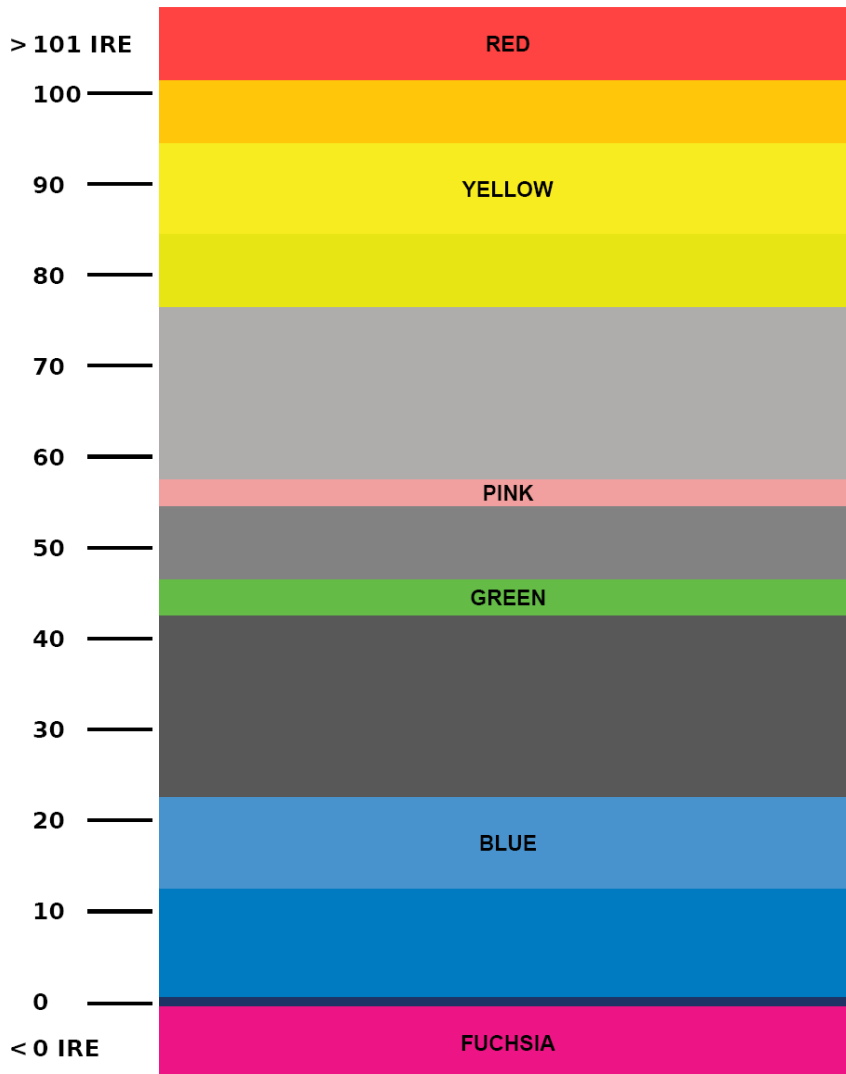

False Color Key

FILTER CONFIGURATION SUBMENU (continued)

■ Peaking Filter (Focus assist)

The Peaking Filter is used to aid the camera operator in obtaining the sharpest possible picture. When activated, all color will be removed from the display and a black-and-white image will remain. The internal processor will display RED color on the screen where sharp edges appear. When the camera operator adjusts (racks) the focus control (on the camera lens), different parts of the image will have RED colored edges. This indicates that the portion of the image is sharp – or in focus. Final focus is achieved by racking the camera lens focus control back and forth until the desired portion of the image has RED colored edges. Please note that this feature is most effective when the subject is properly exposed and contains enough contrast to be processed.

■ Mosquito Filter

Use this setting to filter out “Mosquito Noise” – an artifact that appears as specs around edges of objects. This artifact is the result of video that has been compressed at some point. Video sources from DVD-Players, PDA's, Digital Cable Boxes, Camcorders, etc. often have this artifact.

SYSTEM CONFIGURATION SUBMENU

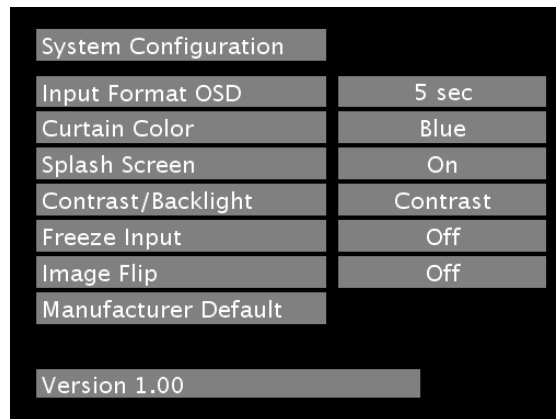

System Configuration	
Input Format OSD	5 sec
Curtain Color	Blue
Splash Screen	On
Contrast/Backlight	Contrast
Freeze Input	Off
Image Flip	Off
Manufacturer Default	
Version 1.00	

System Configuration Submenu

■ Input Format OSD

Use this option to control the behavior of the on-screen display of input/format status. Choices are Off, On (Always) and 5 Sec (On for 5 seconds, then Off).

■ Curtain Color

When the input is lost, or if no signal is present, the Curtain is displayed. Curtain color can be assigned Blue, Back, or Green.

SYSTEM CONFIGURATION SUBMENU (continued)

■ Splash Screen

When monitor is first turned on, the “Marshall Electronics” Splash Screen is displayed. This menu item allows the Splash Screen to be disabled upon power-up.

■ Contrast/Backlight

This monitor has an adjustable LED Backlight. Switching this menu item to Backlight, changes the function of the Contrast Knob to control the backlight level. Range is from 0-100% of the adjustable range. *Note* Backlight will remain ON with at the minimum setting.

■ Freeze Input

Use the Freeze function to “freeze” the current image on the screen. Select this menu item again (Off) to return to the real-time video input.

■ Image Flip

Use this function to Flip the video image on the screen. (Top to Bottom). This is useful when a camera or monitor is inverted.

■ Manufacturer Default

Select this menu item to reset all adjustments and menu settings to the factory default configuration.

FUNCTION PRESETS SUBMENU

System Configuration	
Function on F1	Ratio
Function on F2	Center Marker
Function on F3	Pixel-to-Pixel
Function on F4	Aspect Markers

■ User-Definable Function Buttons

Use the **Function on F1, F2, F3 and F4** menu items to define each function button on the front panel of the monitor. The following options are available for each button:

- Ratio
- Check Field
- Image Flip
- Mosquito Filter
- Peaking Filter
- False Colors
- Freeze Input
- Aspect Markers
- Center Marker
- Marker Enable
- Underscan
- H/V Delay
- Pixel-to-Pixel

Specifications

■ PANEL

Screen Size	7.0" Diagonal
Display Area (h x v)	152.40 x 91.44 mm
Aspect Ratio	15:9 (16:9 / 4:3 Selectable)
Pixels	800 x 480
Color Depth	18-bit (262,144 Colors)
Viewing Angle (h x v)	140° x 100° (CR >10)
Brightness	450 cd/m ²
Contrast Ratio	600:1
Dot Pitch (h x v)	0.0635 x 0.1905 mm
Pixel Pitch (h x v)	0.1905 x 0.1905 mm

■ VIDEO INPUT/OUTPUT

Video Input / Output

Supports SMPTE 170M, NTSC/PAL

YP_BP_R Input / Output

Supports SMPTE 260M, 274M, 296M

3G-SDI Input / Output

Supports SMPTE 292M, 259M, 424M

■ CONNECTORS

Video Input

Video	1 x BNC Female (75 Ω)
YP _B P _R	3 x BNC Female (75 Ω)

Video Output (Active Loop-Through)

Video	1 x BNC Female (75 Ω)
YP _B P _R	3 x BNC Female (75 Ω)

3G-SDI Input

3G-HD-SDI	1 x BNC Female (75 Ω)
-----------	-----------------------

3G-SDI Output (Active Loop-Through)

3G-HD-SDI	1 x BNC Female (75 Ω)
-----------	-----------------------

Power Input

4-Pin Male XLR

Pin 1:	GND
Pin 2:	N/C
Pin 3:	N/C
Pin 4:	+12VDC

■ ELECTRICAL

Power Consumption	1 Amp (Max) @ 12VDC (12 W Max)
Voltage Requirement	12VDC (10VDC-18VDC)

V-PS12-5V-XLR Power Supply:

Input	100V-240V, 1.5A, 50-60Hz
Output	12VDC, 5A, 60W Max

■ BATTERY ADAPTER

Field-Interchangeable Battery Adapter Options
(Sold Separately):

Marshall Adapter	Battery Type	Battery Voltage	Recommended Battery
IDX	V-Mount	14.4 V	IDX E7S
AB	Anton Bauer	14.4 V	Anton Bauer Hytron 50
CM	Canon	7.4 V	Canon BP-970G
PM	Panasonic	7.2 V	Panasonic CGA-D54
PV	Panasonic	7.2 V	Panasonic VW-VBG6
JM	JVC	7.2 V	JVC BN-V438U
SB	Sony BP	14.4 V	Sony BP-U60
SM	Sony NP-Q	7.2 V	Sony NP-QM91
SL	Sony NP-F	7.2 V	Sony NP-F970

■ MECHANICAL

Dimensions (w x h x d): 7.03" x 5.67" x 2.17"

Additional Mounting: ¼"-20 Mounting Bracket

Weight (Monitor Only): 1.90 lbs
 Operating Temperature: 32°F to 95°F (0°C to 35° C)
 Storage Temperature: -4°F to 104°F (-20°C to 40° C)

RoHs: Do not dispose. Return to Manufacturer or Authorized Recycle Facility.

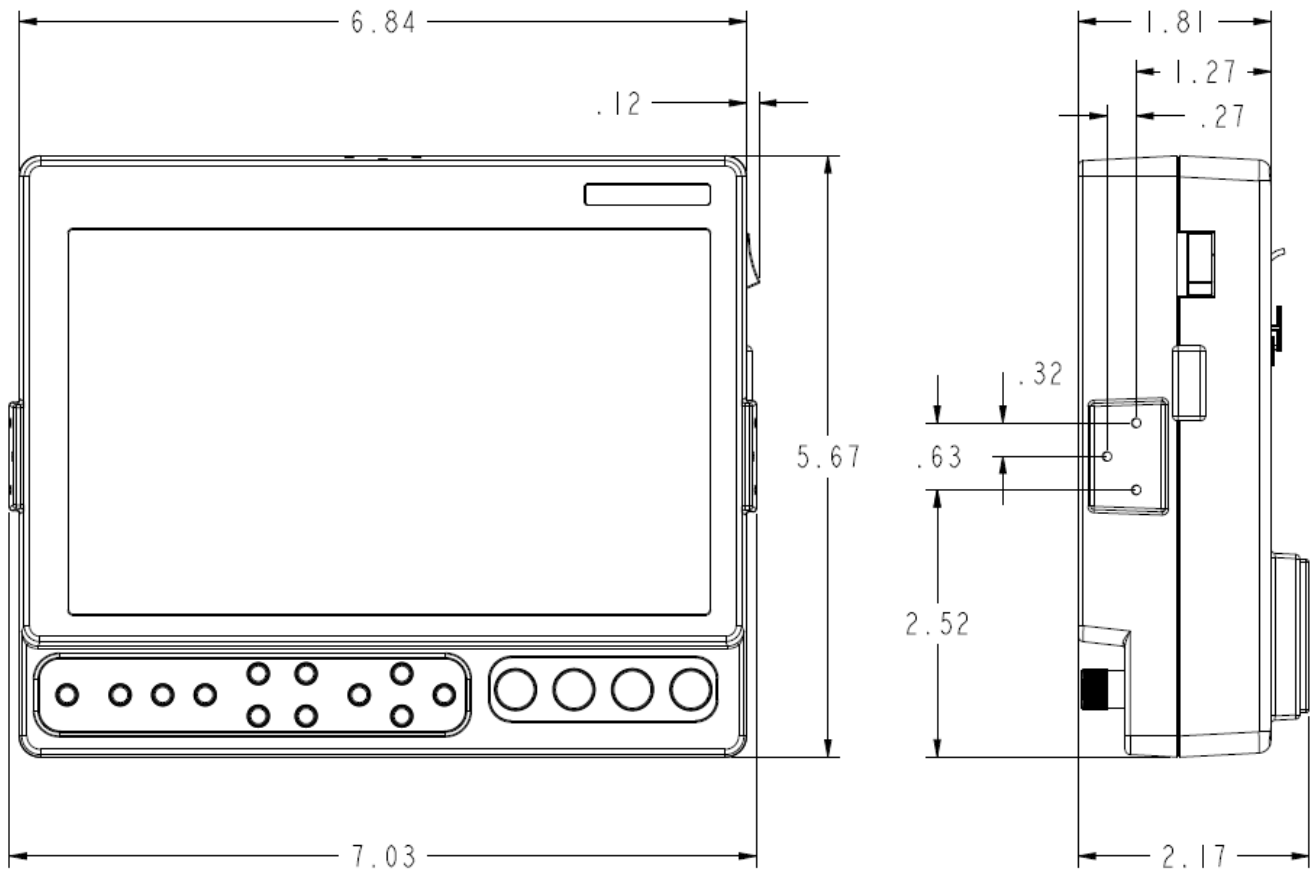

Maintenance

■ Screen Cleaning

Periodically clean the screen surface using ammonia-free cleaning wipes (Marshall Part No. **V-HWP-K**). A clean micro-fiber cloth can also be used using only non-abrasive and ammonia-free cleaning agents. Do not use paper towels. Paper towel fibers are coarse and may scratch the surface of the polycarbonate faceplate or leave streaks on the surface. Antistatic and fingerprint resistant cleaning agents are recommended. Do not apply excessive pressure to the screen to avoid damaging the LCD.

■ Faceplate Dusting

Dust the unit with a soft, damp cloth or chamois. Dry or abrasive cloths may cause electrostatic charge on the surface, attracting dust particles. Neutralize static electricity effects by using the recommended cleaning and polishing practice.

Warranty

Marshall Electronics warrants to the first consumer that this **V-LCD70XP-3GSDI** LCD monitor will, under normal use, be free from defects in workmanship and materials, when received in its original container, for a period of one year from the purchase date. This warranty is extended to the first consumer only, and proof of purchase is necessary to honor the warranty. If there is no proof of purchase provided with a warranty claim, Marshall Electronics reserves the right not to honor the warranty set forth above. Therefore, labor and parts may be charged to the consumer. This warranty does not apply to the product exterior or cosmetics. Misuse, abnormal handling, alterations or modifications in design or construction void this warranty. *It is considered normal for a minimal amount of pixels, not to exceed three, to fail on the periphery of the display active viewing area.* Marshall Electronics reserves the option to refuse service for display pixel failure if deemed unobtrusive to effective use of the monitor by our technicians. No sales personnel of the seller or any other person is authorized to make any warranties other than those described above, or to extend the duration of any warranties on behalf of Marshall Electronics, beyond the time period described above. Due to constant effort to improve products and product features, specifications may change without notice.

Marshall Electronics, Inc.

1910 East Maple Ave.

El Segundo, CA 90245

Tel: (800) 800-6608 / (310) 333-0606 • Fax: 310-333-0688

www.LCDRacks.com • sales@lcdracks.com